

# GU\_AT Trigger系接続図 2016/06/30 作成

## Main Trigger Station

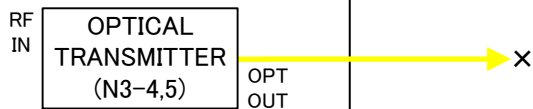

## GU AT HV Station

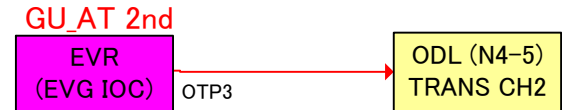
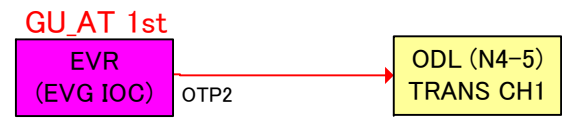
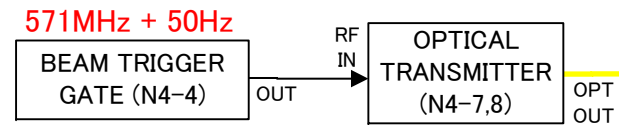
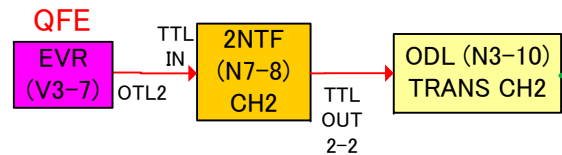
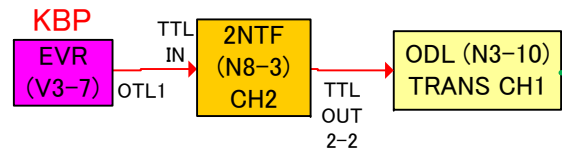
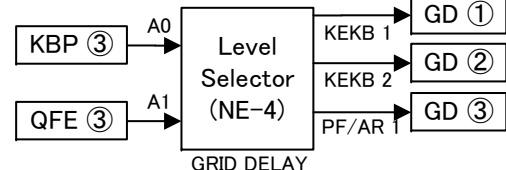
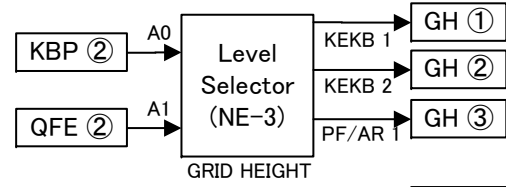
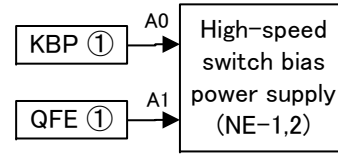
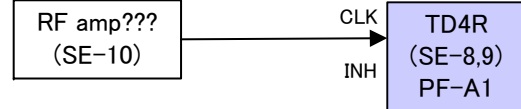
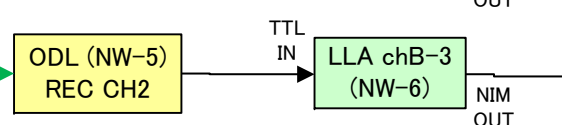
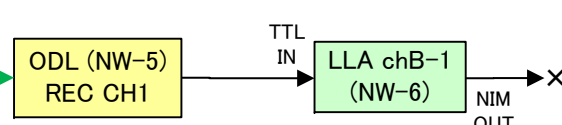
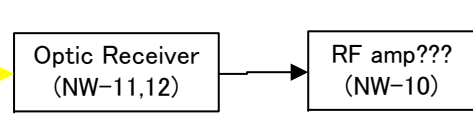
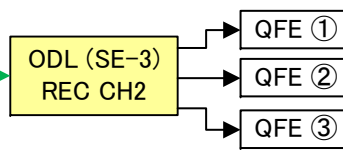
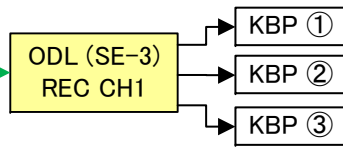

- 2NTF** ← 2CH chA- FANOUT
- LLA** ← LOGIC LEVEL ADAPTER
- TD4RA** ← Timing Delay TD4RA
- TD4R** ← Timing Delay TD4R
- GRID PULSER** ← HMPI/NIM High Voltage Pulser, Kentech
- ODL** ← Optical Data Link

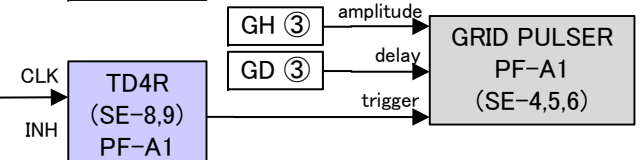
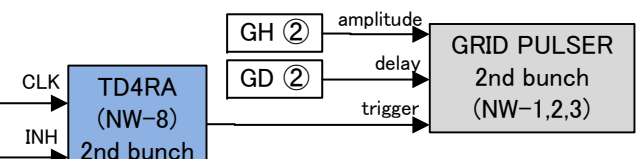
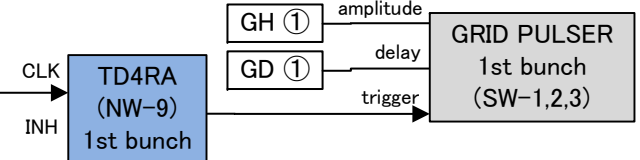

# GU\_AT HV-ST NIM BIN 使用状況 2016/06/30 作成

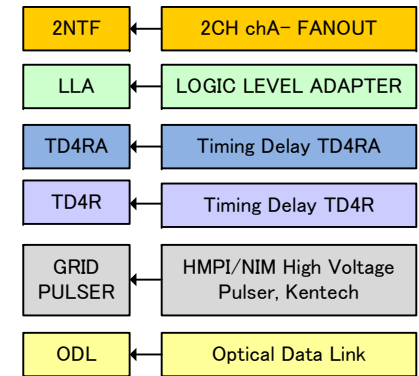

**NE** 上:左、下:右

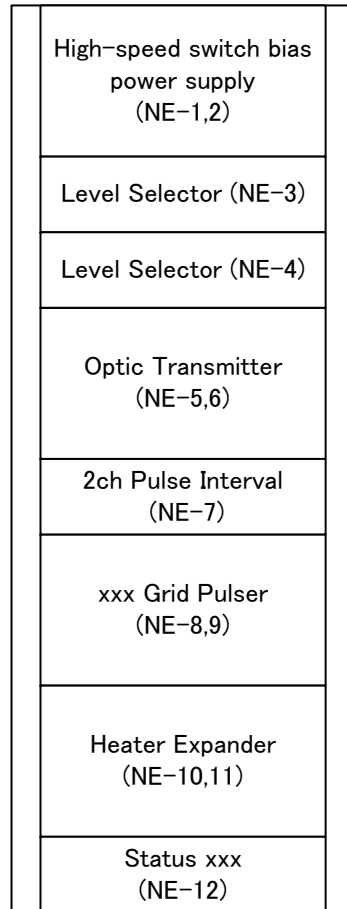

**NW** 上:左、下:右

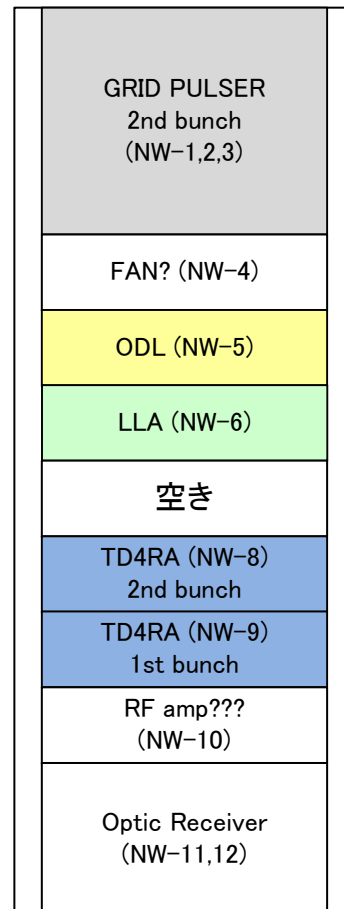

**SW** 上:左、下:右

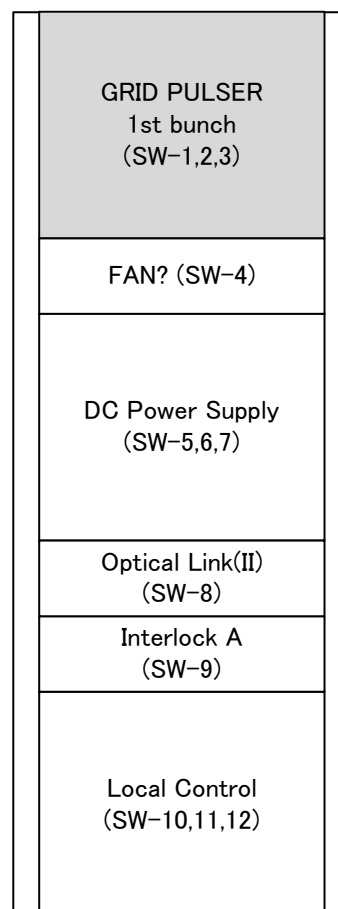

**SE** 上:左、下:右

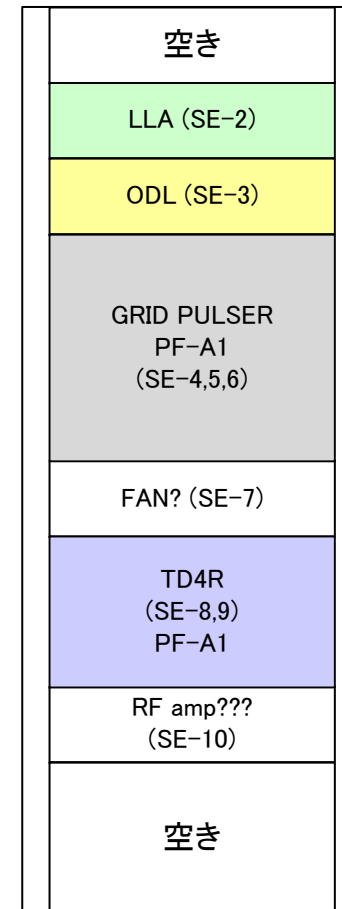

# GU\_AT Trigger系 6/16案 接続図 2016/06/30 作成

## Main Trigger Station

## GU AT HV Station

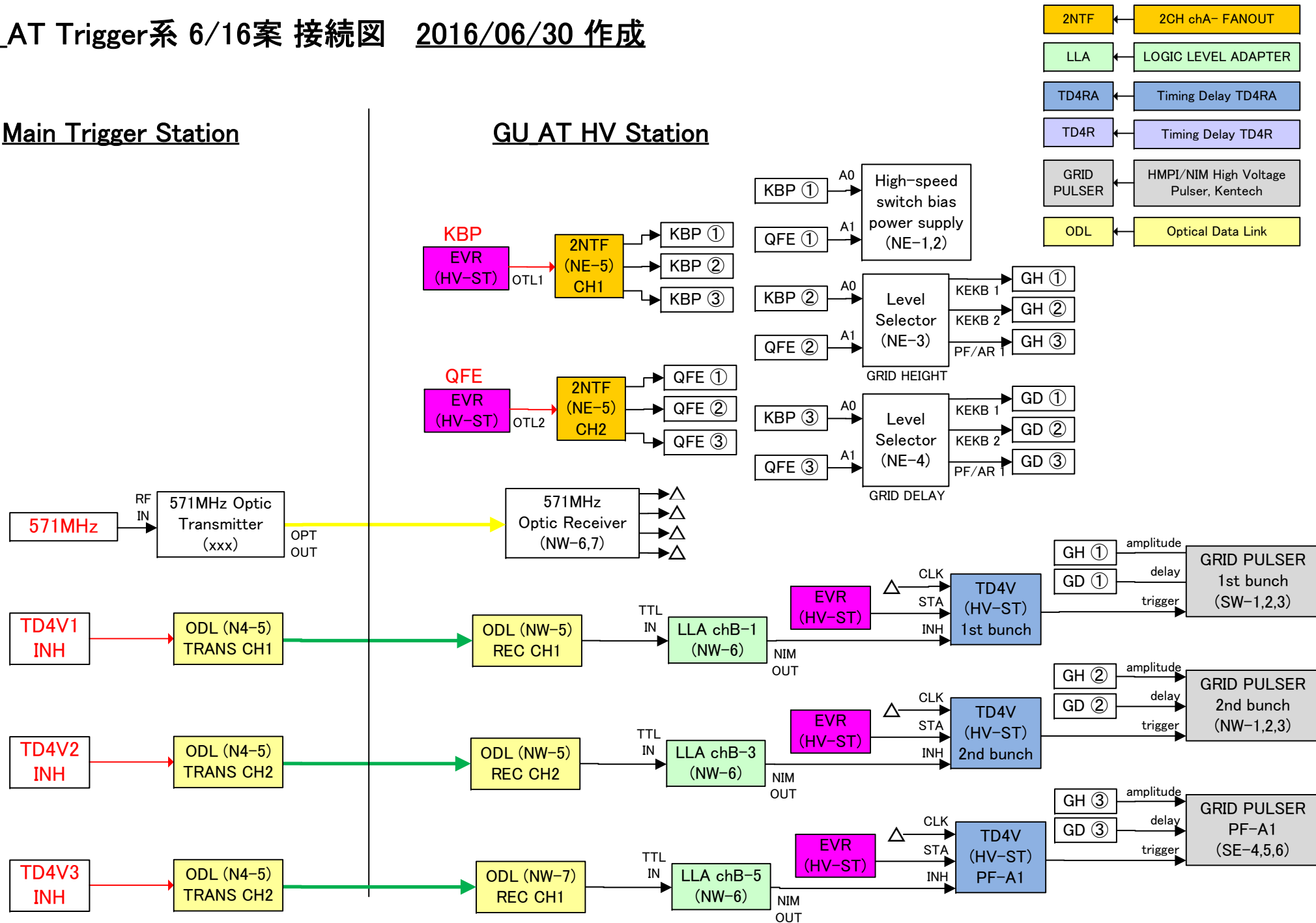

# GU\_AT HV-ST NIM BIN 6/16案 2016/06/30 作成

NE 上:左、下:右

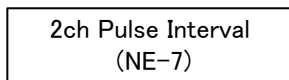
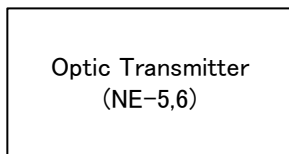
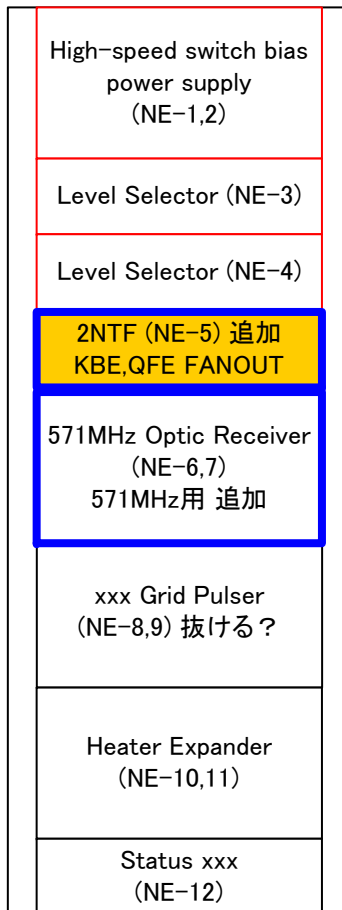

NW 上:左、下:右

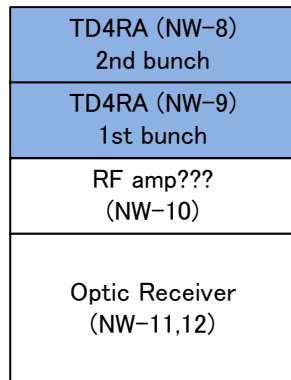
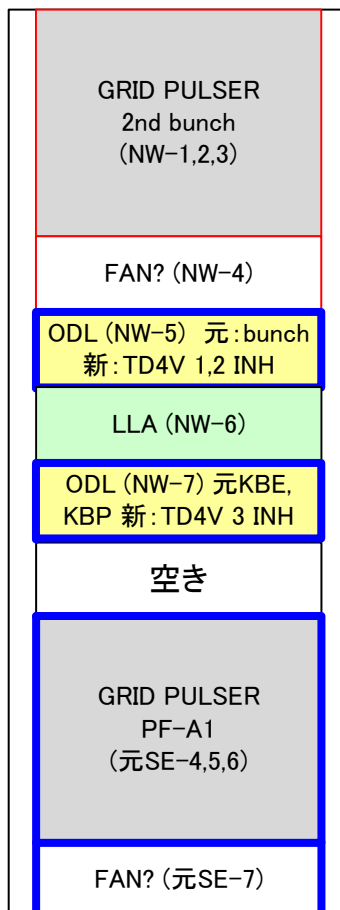

SW 上:左、下:右

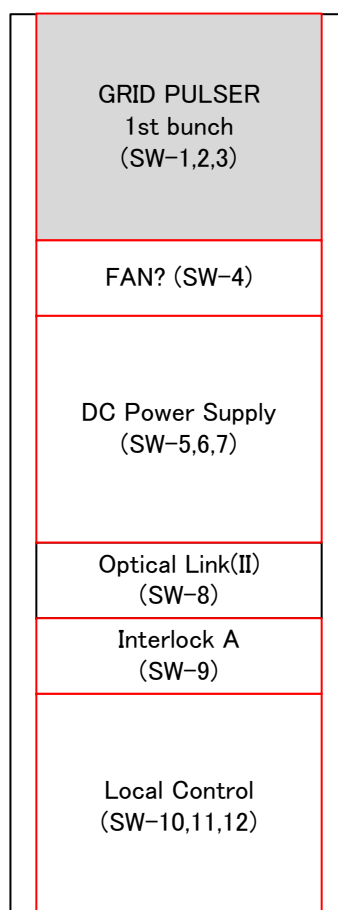

SE 上:左、下:右

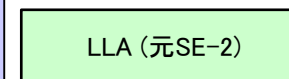
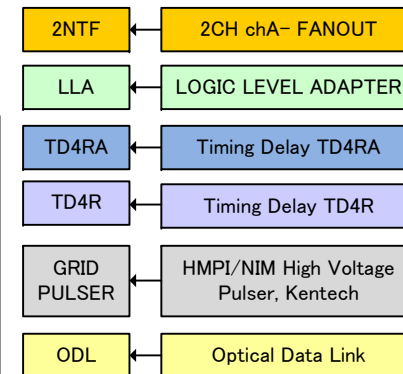
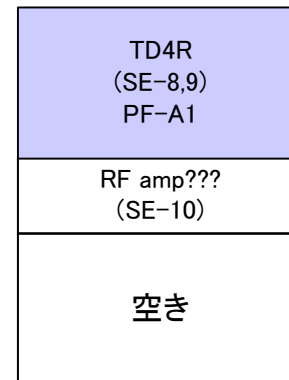
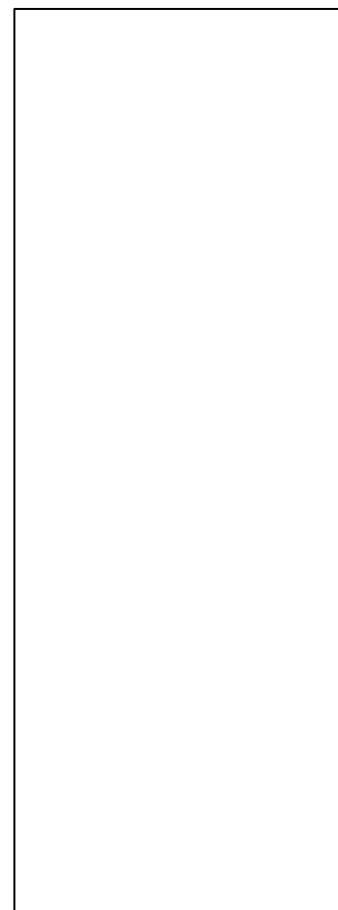

# GU\_AT Trigger系 接続図 2016/09/28 作成

## Main Trigger Station

## GU AT HV Station

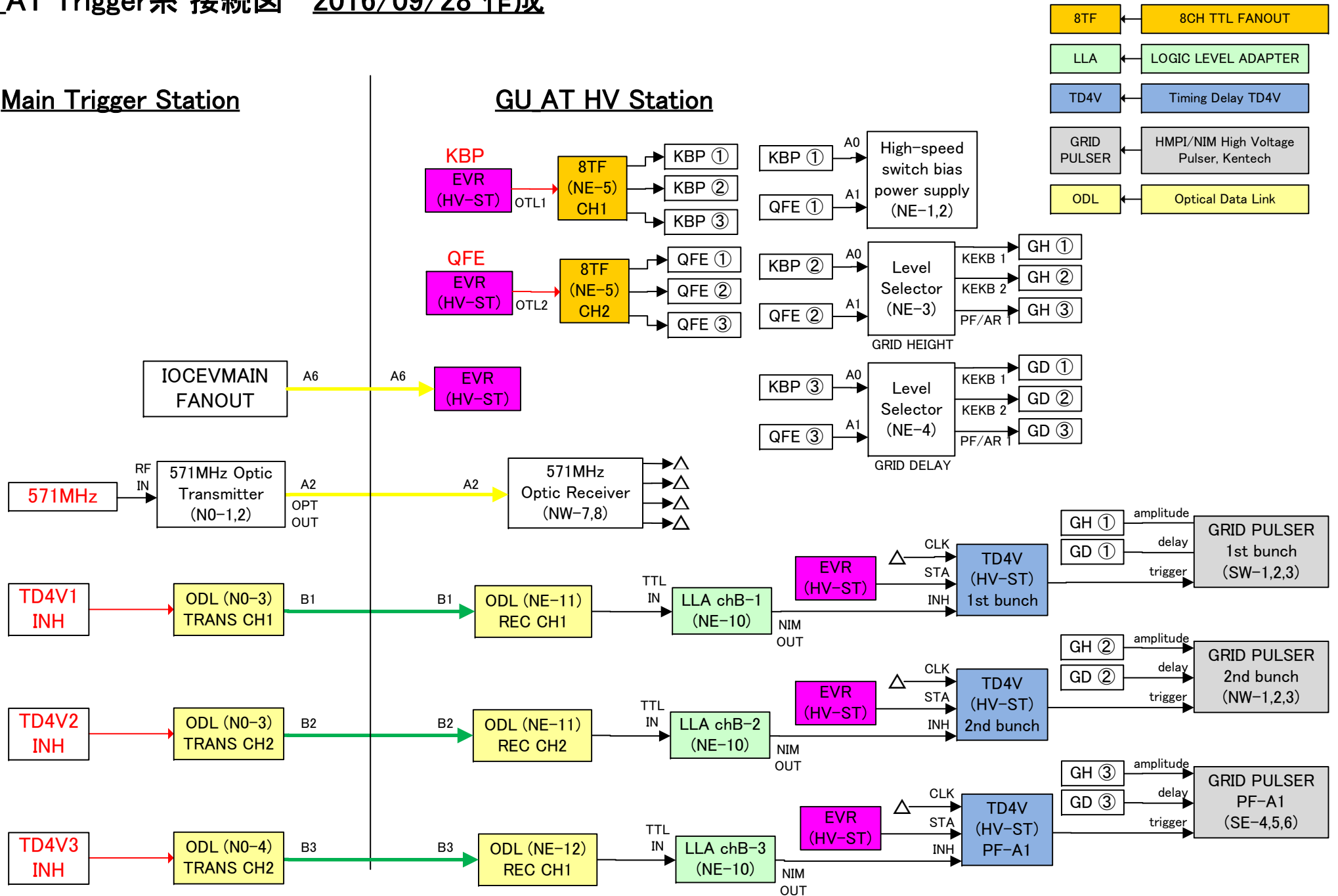

# GU\_AT HV-ST NIM BIN 2016/09/28 作成

NE 上:左、下:右

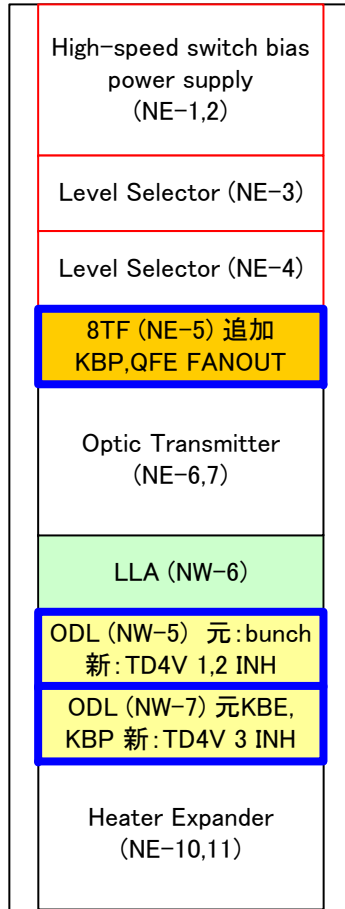

xxx Grid Pulser (NE-8,9) 抜ける?

Status xxx (NE-12)

NW 上:左、下:右

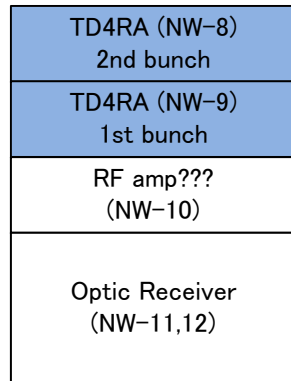
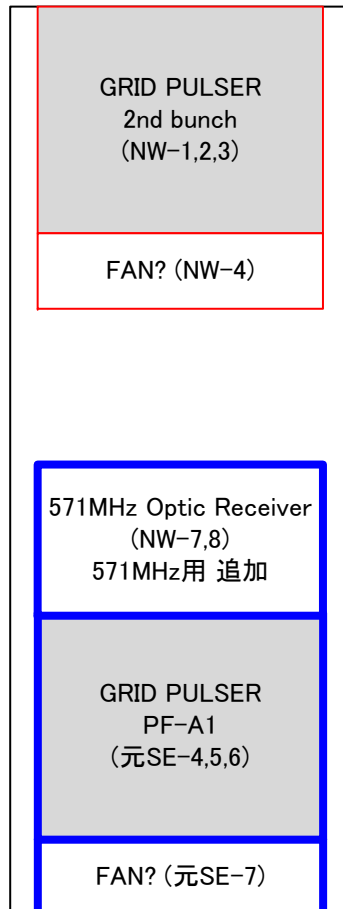

SW 上:左、下:右

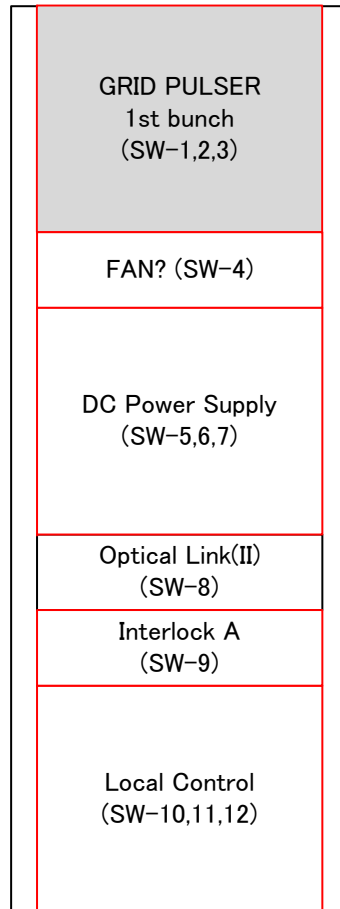

2ch Pulse Interval (NE-7)

SE 上:左、下:右

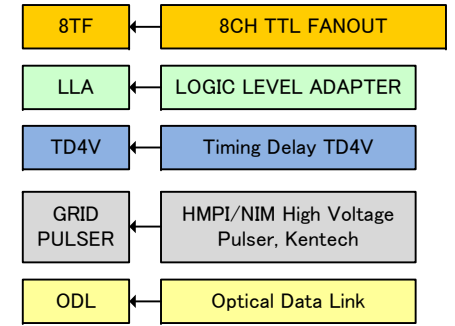
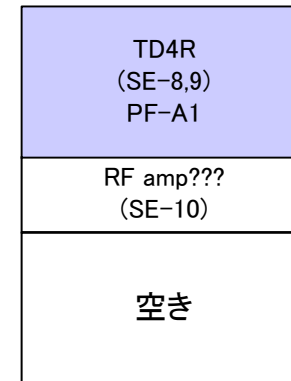

LLA (元SE-2)