

# SuperKEKB status and 2024c operation schedule

Gaku Mitsuka (KEK, Accelerator Laboratory)

B2GM, 7 Oct. 2024

Special thanks to K. Shibata, M. Tobiyama, K. Trabelsi, S. Uno, K. Uno, F. Miyahara, N. Iida, Y. Ohnishi, Y. Funakoshi, S. Terui, T. Ishibashi, H. Sugimoto, R. Ueki, and many others.



# Outline

- Highlights from 2024ab operation
- Major work during the summer shutdown
- 2024c operation schedule
- Summary

# Overview of 2024ab linac operation

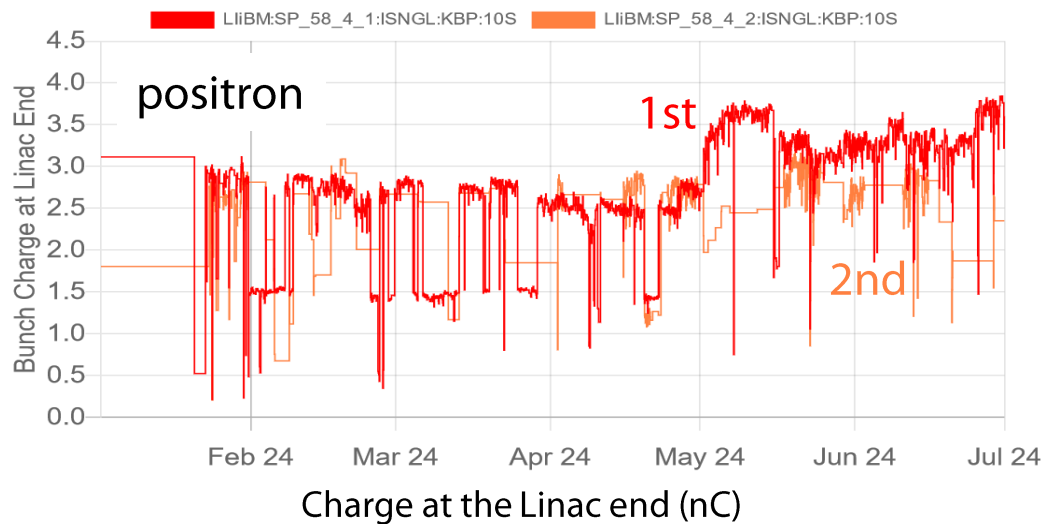
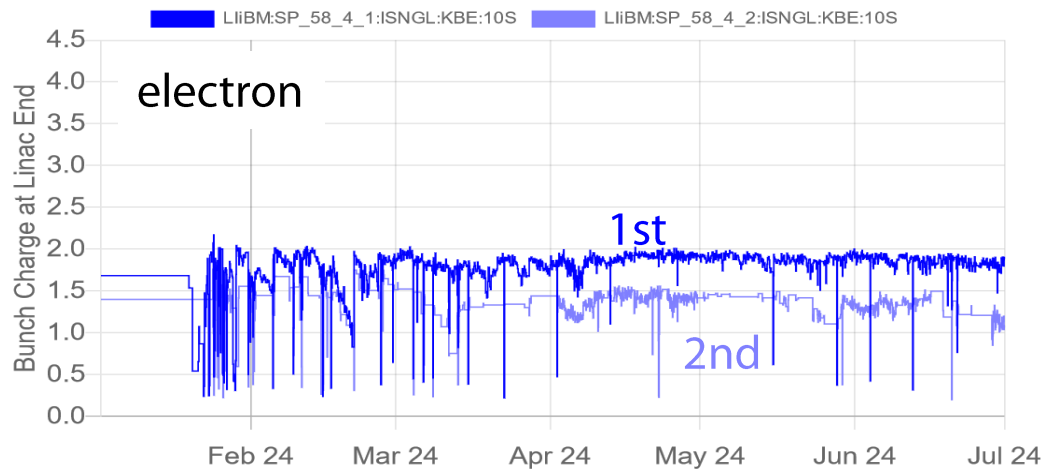

- Charge at the Linac end has been stable.
- 2-bunch operation was limited for a short period due to injection-induced abort and lower efficiency.

Electron Emittance

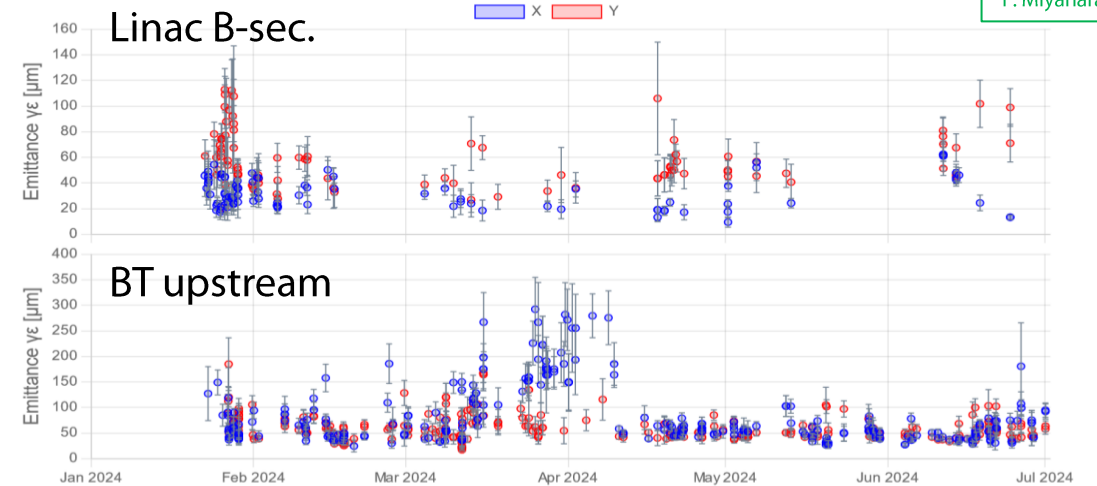

F. Miyahara, N. Iida

Positron Emittance

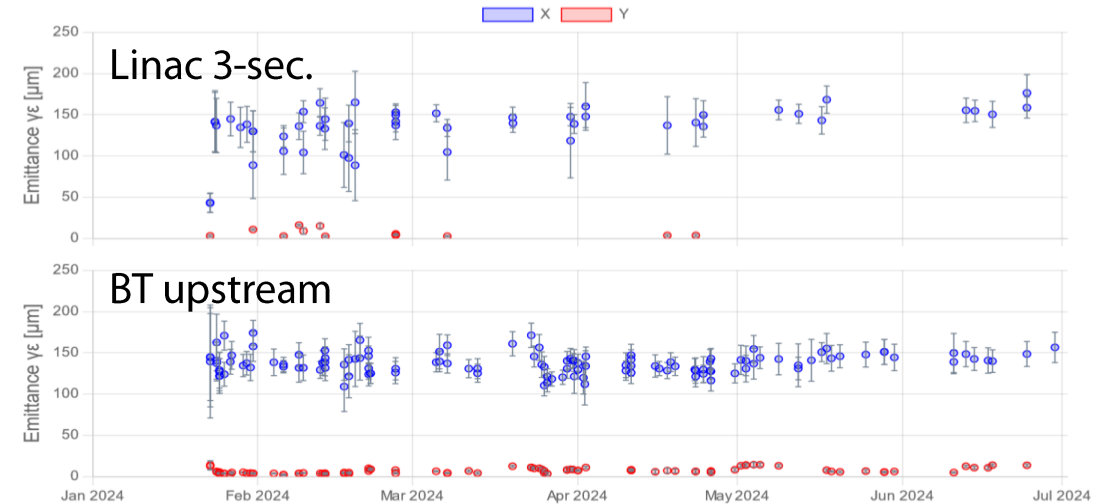

- The 2nd-bunch emittances are a little bit larger.
- The emittance blowups downstream of the BT1 are one of the most significant challenges to injections.

# Overview of 2024ab beam injection

N. Iida

- **The both rings were in severe condition for beam injection.**
- **Ring acceptance to the injection bunch**
  - Emittance, especially in vertical
  - Injection bunch oscillation
    - For a low-current bunch, we obtain an efficiency of 80% thanks to bunch-by-bunch feedback.
- **Dynamic aperture**
  - The vertical aperture becomes narrower at a high bunch current.
  - Measured aperture narrower than the simulation for both rings in three directions (x, y, z)
- **Lifetime of beam tuning**
  - The machine's good emittance condition can be maintained for only a few days.
  - In the second half of 2024ab, once the measured emittance with the SRM of BT became larger, the operator adjusted the A-sector pulsed steering magnets to recover the condition.

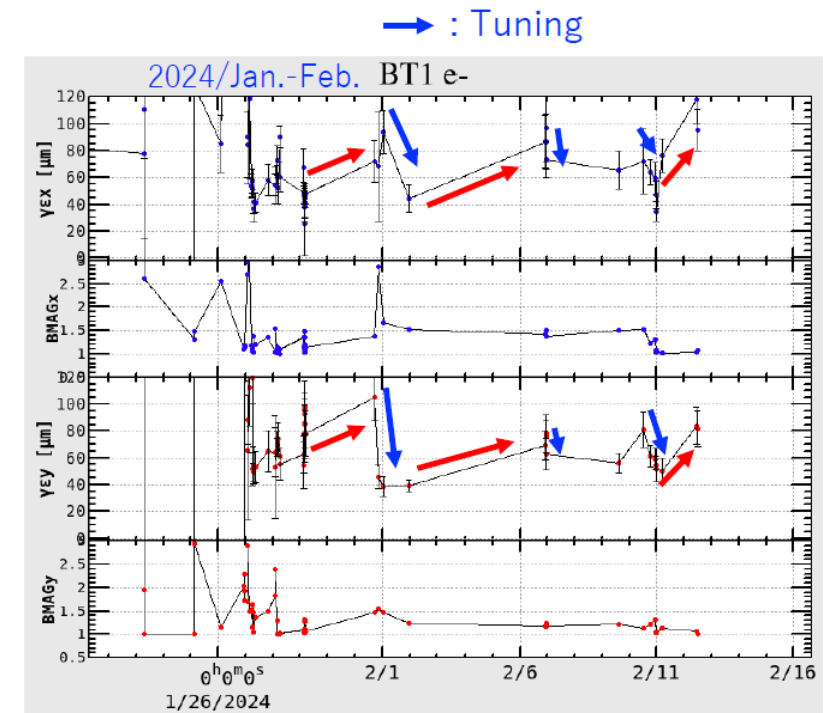

Beam tuning in LINAC improves the emittance, but **keeps it only a few days.**

# Overview of 2024ab main ring operation

- **29 Jan. – 20 Feb.:**
  - Vacuum scrubbing, machine tuning & study
- **20 Feb. – 1 Jul.:**
  - Physics run, machine tuning & study
  - Struggling with Sudden Beam Loss (SBL), poor injection efficiency, and low machine stability
  - Injection efficiency degraded due to beam-beam Interaction effects at high bunch current.
  - SBL, injection beam, 2-bunch operation caused many beam aborts.
  - $\beta_y^*$  was squeezed down to 0.9 mm (mostly 1 mm).
  - Maximum beam current : HER/LER = 1.21/1.54 A
  - Number of bunches mostly at 2346, finally at 2249
  - Chromatic X-Y coupling correction by rotatable sextupole magnets

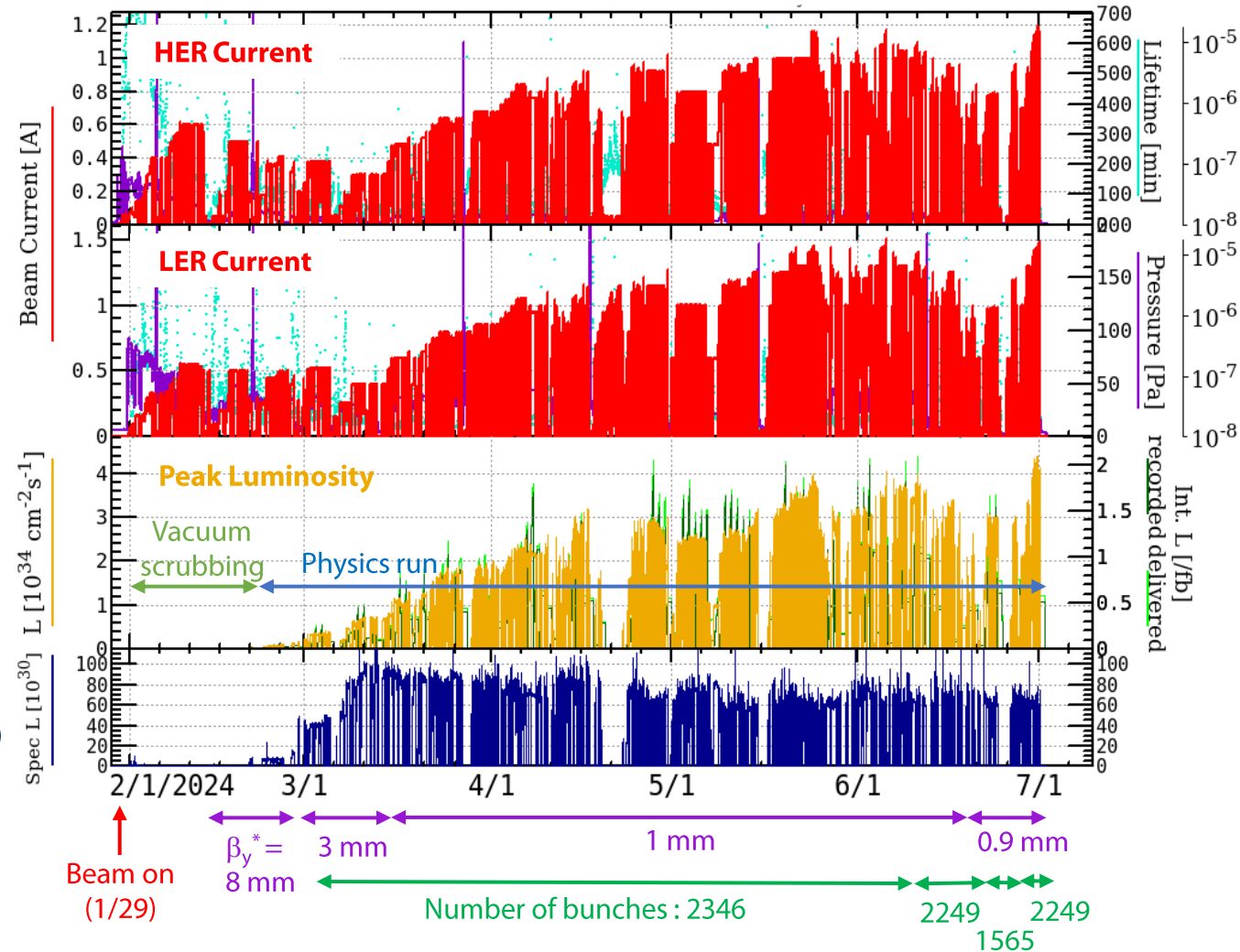

# Overview of 2024ab main ring operation

Y. Ohnishi  
(KEKB review, Mar. 2024)

## Strategy of 2024b Run

- **Peak luminosity  $L_p = 4.47 \times 10^{34} \text{ cm}^{-2}\text{s}^{-1}$** 
  - Specific luminosity  $L_{sp} = 5.9 \times 10^{31} \text{ cm}^{-2}\text{s}^{-1}/\text{mA}^2$
  - $\beta_y^* = 0.9 \text{ mm}$
  - **Beam current: HER/LER = 1.18/1.45 A**
  - Number of bunches: 2249
  - Bunch current product ( $I_{b+}I_{b-}$ ):  $0.338 \text{ mA}^2$
  - Crab waist ratio: HER/LER = 60/80%
    - Crab waist ratio went from 40/80% to 60/80%
    - effective to increase luminosity and extend  $I_{b+}I_{b-}$
- **Integrated luminosity (2024ab) = 103 fb<sup>-1</sup>**
  - Maximum integrated luminosity/day:  $2.0 \text{ fb}^{-1}/\text{day}$
  - Total integrated luminosity:  $527 \text{ fb}^{-1}$



- Vertical Emittance of Single Beam Is Better than 2022ab Run.
- Luminosity Performance Reaches the Same Level as 2022ab Run.
  - $L_{sp} = 6.5 \times 10^{31} \text{ cm}^{-2}\text{s}^{-1}/\text{mA}^2$  at  $I_{b+}I_{b-} = 0.41 \text{ mA}^2$  ( $I_{b+} = 0.72 \text{ mA}$ )
   
 $L = 6.5 \times 10^{31} \times 0.41 \times 2346 = 6.25 \times 10^{34} \text{ cm}^{-2}\text{s}^{-1}$
- Plan of 2024b Run
  - $\beta_y^* = 1 \text{ mm}$  Operation Will Be Continued to Achieve  $6-8 \times 10^{34} \text{ cm}^{-2}\text{s}^{-1}$ .
    - LER: 2 A / HER: 1.4 A / 2346 Bunches
  - $\beta_y^* = 0.8 \text{ mm}$  Will Be Adopted in June After Above Achievement.
  - Injection Will Constrain Beam Currents.
    - Two-Bunch Injection, 25 Hz Repetition, Sextupole Optimization (Enlarge DA), Synchrotron Phase Space Injection (HER), Investigation of Narrow Vertical Aperture (HER), etc.

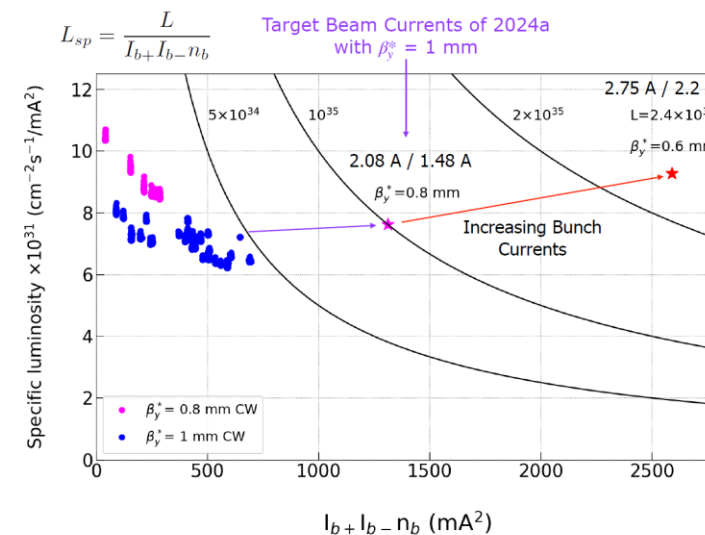

# High-bunch current and beam-beam studies

- **Lessons from high-bunch current studies**

- Vertical single beam size blows up > 0.5 mA/bunch in both rings.

- **Lessons from beam-beam collision studies**

- LER vertical size blows up due to beam-beam effect
- Injection efficiency degraded in beam-beam collisions at high bunch current (77% → 48%).
- Lowering horizontal tune recovers a part of the LER injection efficiency (48% → 65%).

Y. Funakoshi et al.,  
Beam-Beam Effects in Circular Colliders BB24

w/ beam-beam

- Beam lifetime increases w/ beam-beam blowup.
- Injection efficiency get worse seriously  
→ By optimizing working points, the injection efficiency is improved.

	Ibeam (LER)	Ibeam (HER)	IncRate (L)	Life (L)	InjEff (L)
(1)	1395 mA	0 mA	1.68mA/s	7.3 min.	77.4%
(2)	1395mA	1100mA	0.42mA/s	8.9 min.	48.0%
(3)	1444mA	1100mA	1.02mA/s	8.0 min.	64.8%

$$\text{Beam Lifetime [s]} = \frac{\text{DCCT Beam current [mA]}}{\text{DCCT decreasing rate (Loss rate) [\frac{mA}{s}]}}$$

$$\text{Injection Efficiency [\%]} = \frac{\text{DCCT increasing rate [\frac{mA}{s}]} + \text{DCCT decreasing rate [\frac{mA}{s}]}}{\text{BT end charge [nC]} \times \text{Revolution freq. [Hz]} \times 1000 \times \text{InjRepRate [Hz]}} \times 100$$

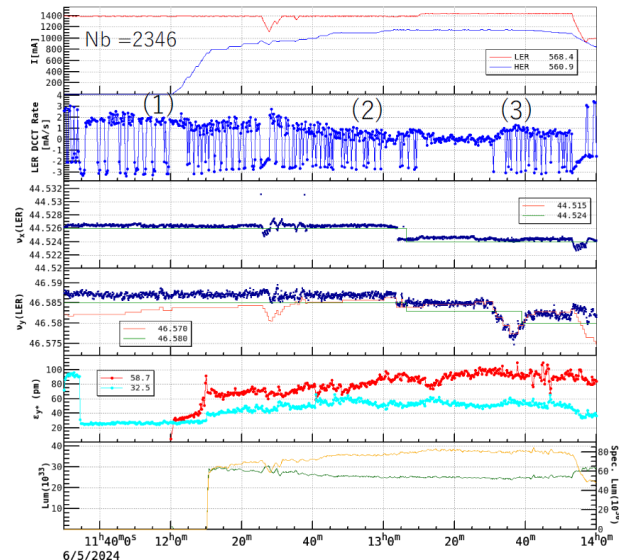
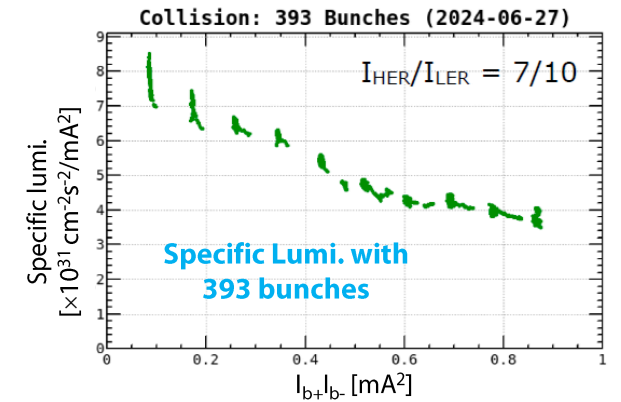
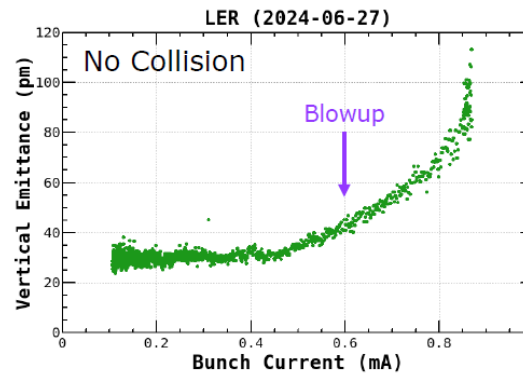
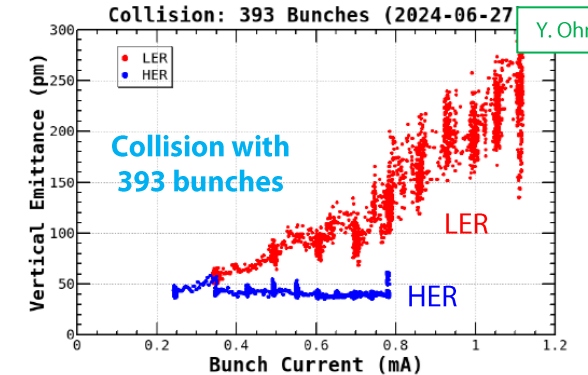
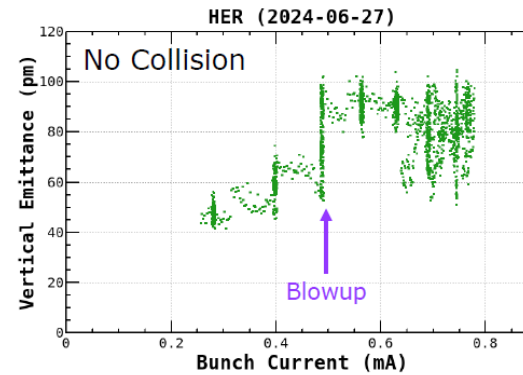

# Sudden Beam Loss (SBL) events

- **Exploring the cause of SBL in 2024ab run**
  - Belle II and SuperKEKB had formed a collaborative team to address the SBL from beam instruments, MDI, and analysis points of view.
- **Many findings were made during the 2024ab run**
  - **SBL happens**
    - with/without collisions
    - even at lower bunch currents
    - not only at  $\beta_y^* = 1\text{mm}$  but also at  $\beta_y^* = 3\text{mm}$ .
  - **In most cases, the pressure spikes in the wiggler sections were observed.**
    - Downstream of Oho Wiggler Section (D04 straight section)
    - Downstream of Nikko Wiggler Section (D10 straight section)
    - Beam pips with electron clearing electrodes for countermeasure against the electron cloud effects in LER
  - **Knocking the beam pipes at wiggler sections with a "knocker" could reproduce SBLs and eventually reduce the number of SBLs.**
    - Higher total currents result in more frequent SBL.
  - **Dust at wiggler sections is the most likely cause of SBL in LER**
    - No data showing discharge in LER collimators.

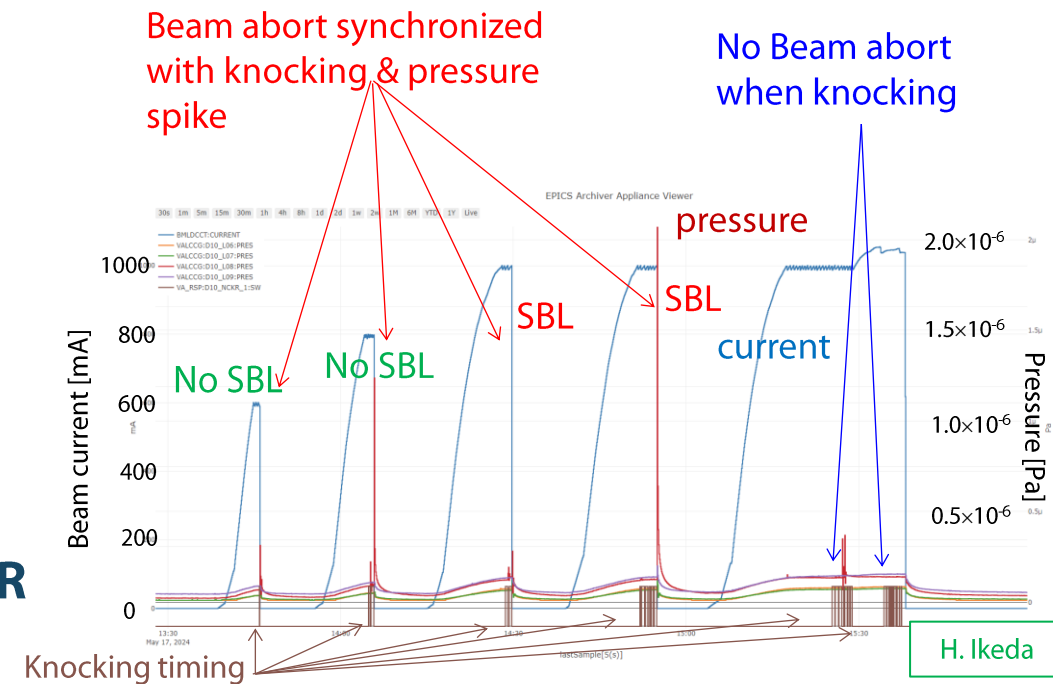
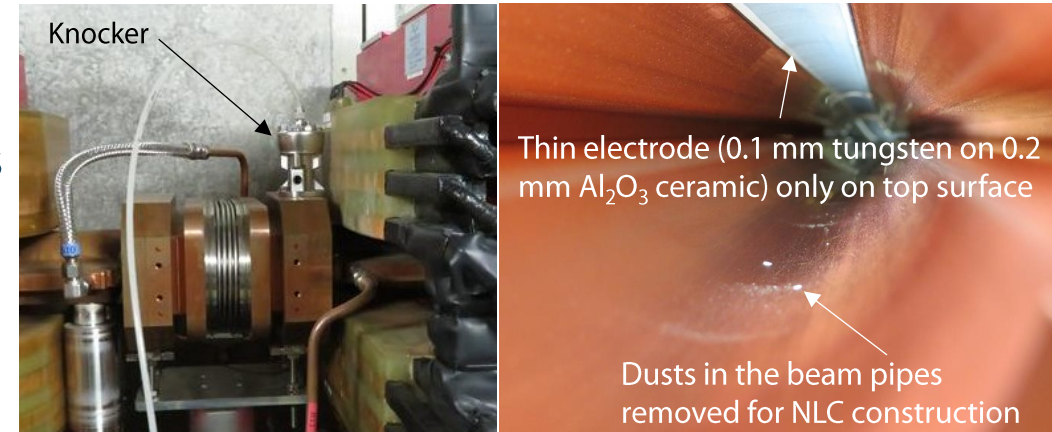



# Beam pipe knocking to detach dust

K. Shibata

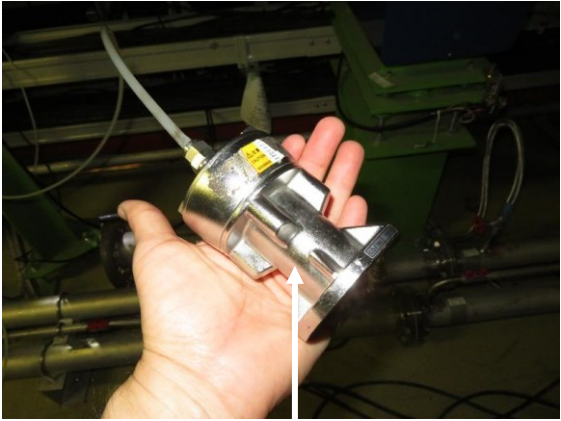

Knocker  
(driven by compressed air)

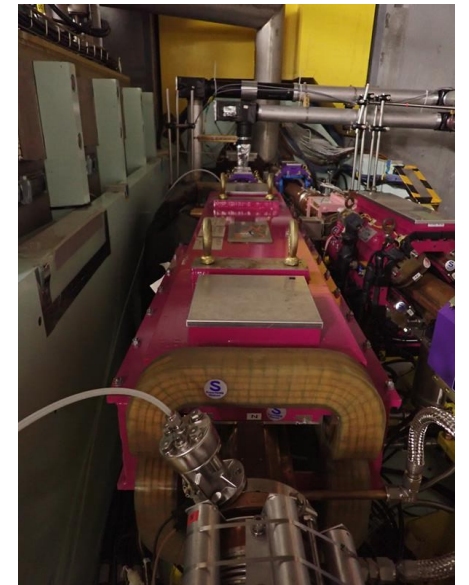

# Outline

- Highlights from 2024ab operation
- Major work during the summer shutdown
- 2024c operation schedule
- Summary

# Linac work in the summer shutdown

F. Miyahara, H. Ego

## Fast pulsed kicker magnets

- Two vertical fast pulsed kickers are placed in the A sector (low-energy section) that can kick only the 2nd bunch.
- The fast pulsed kicker at the SY3 BT line failed due to radiation damage to the power supply. The repaired power supply is waiting for the next installation.
- Effects of the timing jitter was measured at the Linac and BT and found to be  $< 10 \mu\text{m}$ .

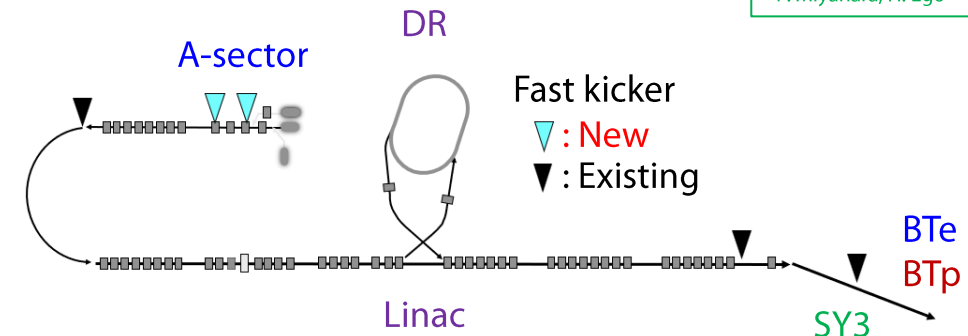
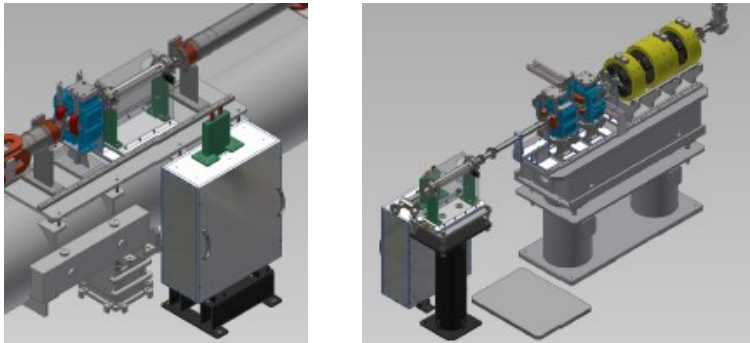

## BT Energy Compression System (BT ECS)

- BT ECS is introduced for countermeasures against energy spreading and long-range wakefield.
- Waveguide installation is almost complete.

## SY3 beam diagnostics line

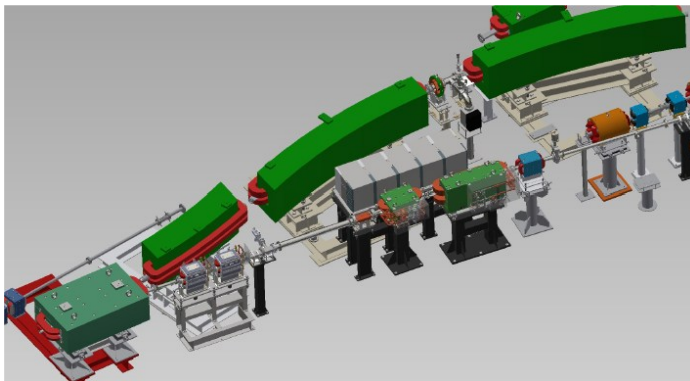

- The construction of the pulsed diagnostic line in SY3 is completed.
- Beam diagnostics can be performed at  $< 5 \text{ Hz}$  in separate beam modes simultaneously with HER injection.



# Countermeasure against SBL

- **Turning beam pipes with electron clearing electrode upside down**
  - 15 beam pipes were turned upside down at the Oho straight section. (56 m/185 m = 30% of the total)
  - **Oho straight section:**
    - 13/16 beam pipes (D04 wiggler section)
    - 2/4 beam pipes (D05 NLC section)
  - **Nikko straight section:** we have kept 30 beam pipes at the Nikko wiggler section unchanged.
- **Visual check and dust cleaning of the beam pipes after turning them upside down**
- **Knocking as many beam pipes as possible (with electron clearing electron or groove structure)**

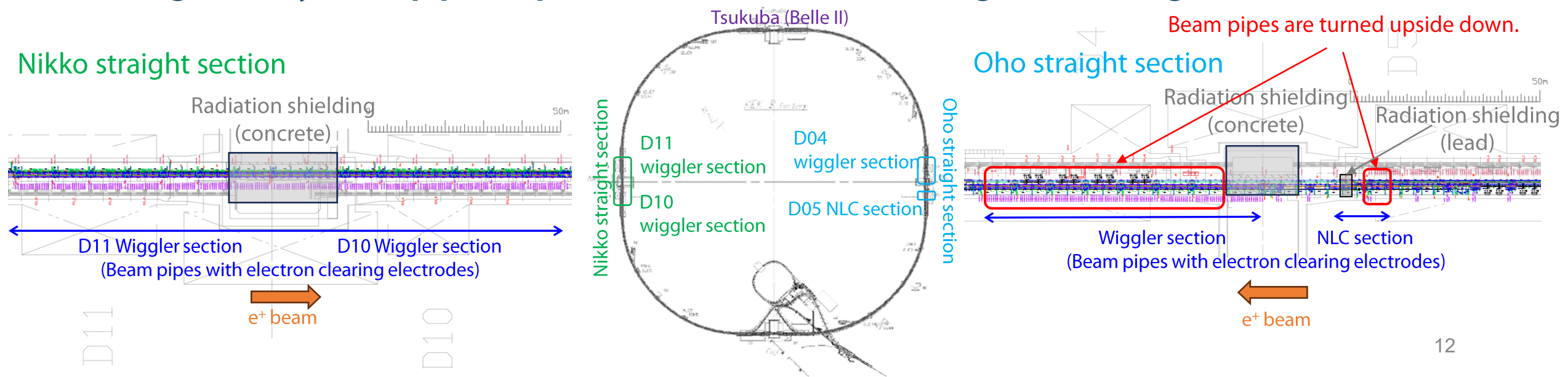
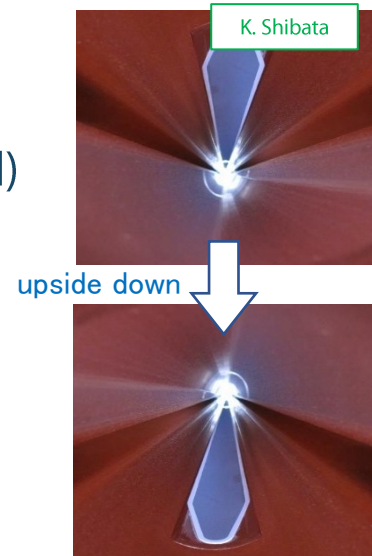

# OHO D04 Wiggler Section

Wiggler magnet disassembly

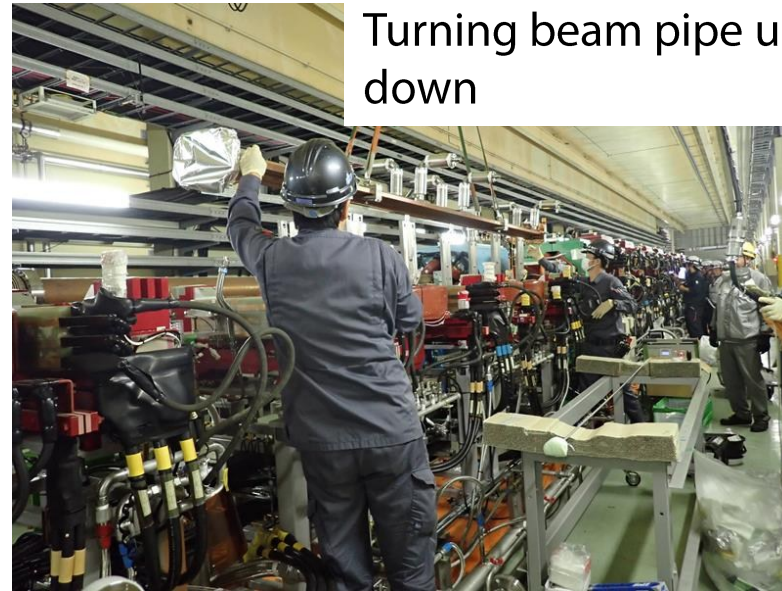

Turning beam pipe upside down



Wiggler magnet reassembly



NEG pump

NEG pump position changes from the bottom side to the top side. NEG pumps are installed horizontally to prevent dusts from falling from NEG.

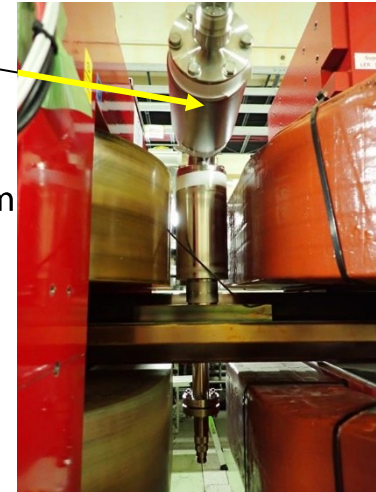

K. Shibata

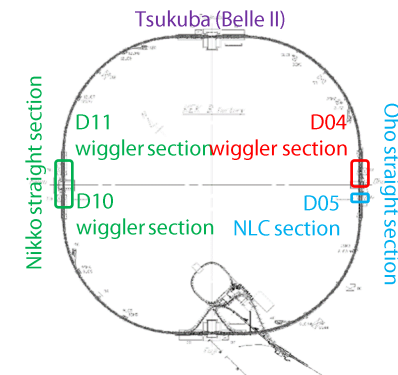

# OHO D05 NLC Section

Turning  
upside down

Radiation shielding (Pb)

D05V1 (NLC)



Beam pipes with electron clearing electrodes



Removal



Reinstallation  
(upside down)

K. Shibata

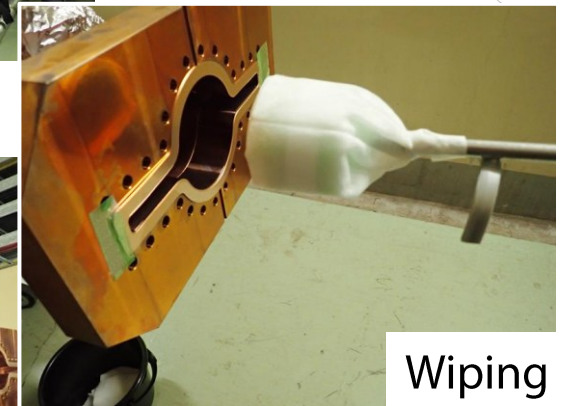
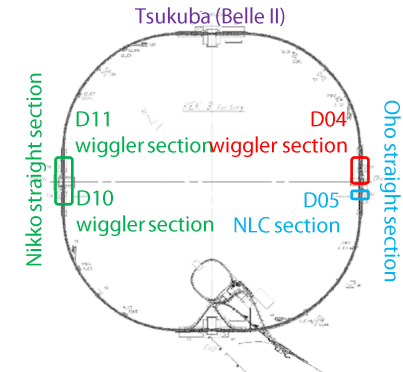

Wiping

# Outline

- Highlights from 2024ab operation
- Major work during the summer shutdown
- 2024c operation schedule
- Summary

# New commissioning team

- Linac
  - Fusashi Miyahara (leader)
- Main ring
  - Gaku Mitsuka (leader)
  - Takuya Ishibashi
  - Hiroshi Sugimoto
  - Ryuichi Ueki
- BT
  - Linac and main ring member



# 2024c schedule

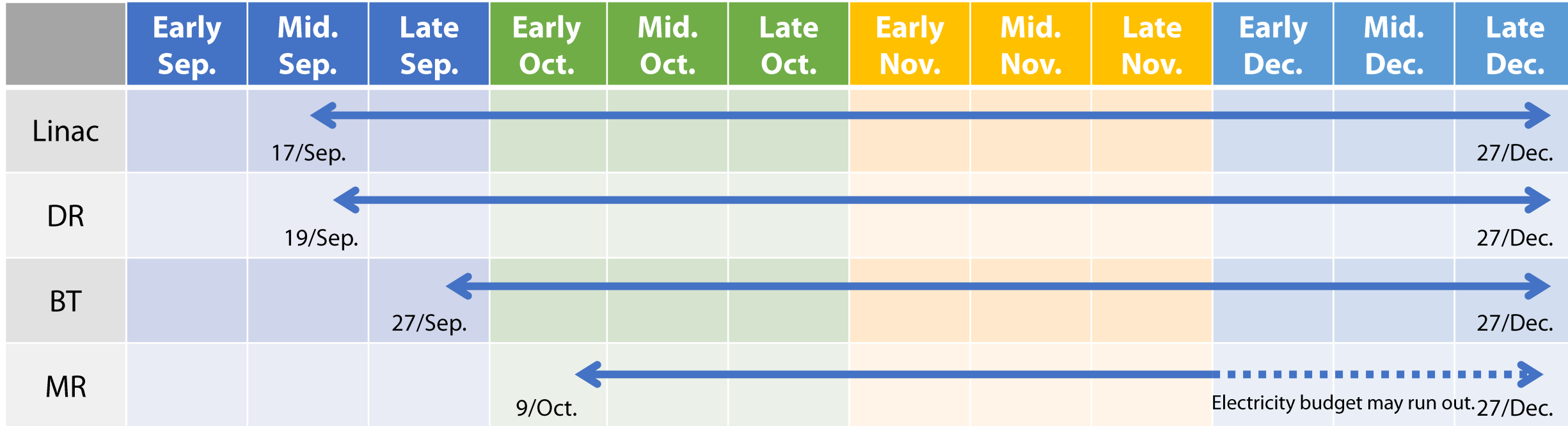

- The budget for MR operation until the end of November has been secured.
- We are trying to get the budget for MR operation in December.

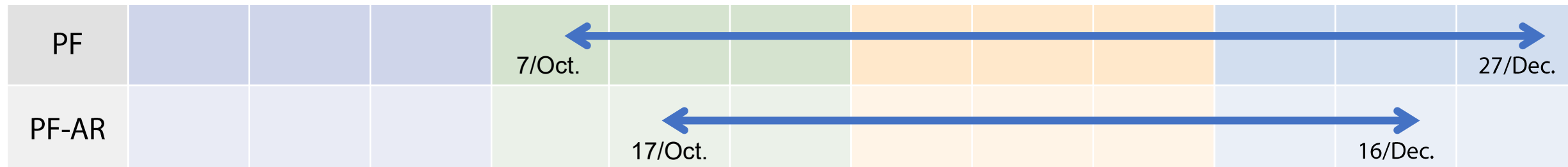

# 2024c target performance

- Target luminosity of 2024c run is  $1 \times 10^{35} \text{ cm}^{-2} \text{ s}^{-1}$ .
- The strategy is to increase the beam current to 2.58A (LER)/1.83A (HER) with 2346 bunches.
- $\beta_y^*$  will be kept at 0.9 mm.
- $L_{sp} = 5 \times 10^{31} \text{ cm}^{-2} \text{ s}^{-1}$  was achieved already in 2022b with a smaller number of bunches (393 bunches).



Strategy toward  $2.4 \times 10^{35} \text{ cm}^{-2} \text{ s}^{-1}$

$$L_{sp} = \frac{L}{I_{b+} I_{b-} n_b}$$

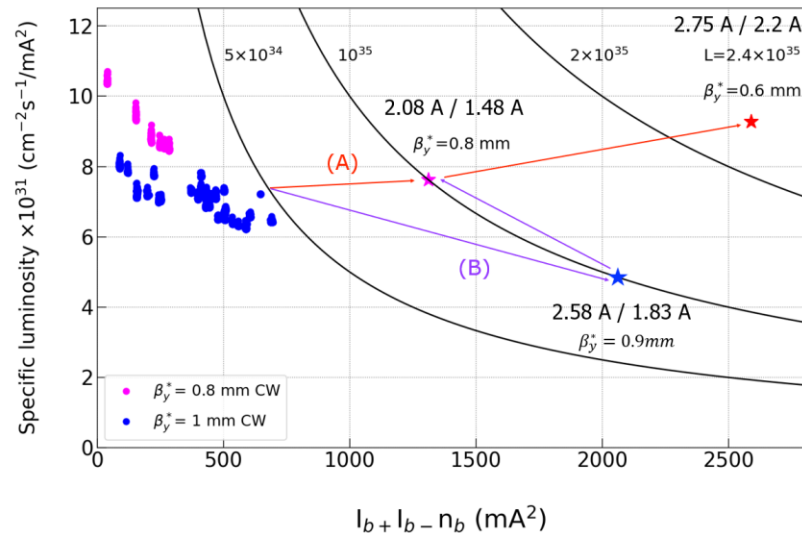

Y. Ohnishi

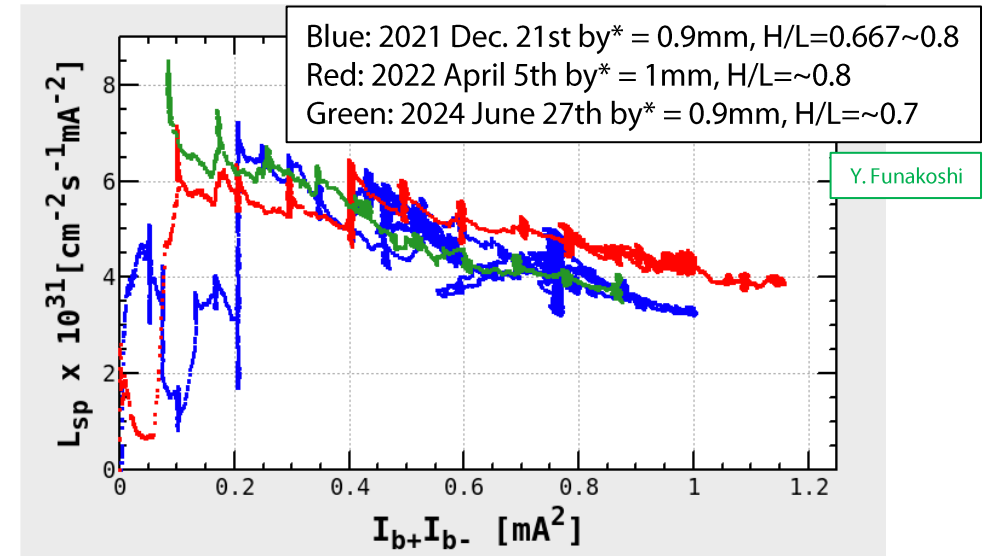

Y. Funakoshi

We adopt route (B) as the path to  $1 \times 10^{35}$ .

# Startup & vacuum scrubbing

- **9 Oct. - 21 Oct. (12 days)**

- Startup and hard/software tuning from HER followed by LER
- Use the detuned optics through vacuum scrubbing
- Vacuum scrubbing
  - Target dose: ~100 Ah
  - Establish 2024b's highest beam current or more
    - > 1.2 A in HER / 1.5 A in LER

- **Study items**

- Linac-BT tuning, ML-assisted orbit tuning
- New NLC optics ( $\beta_x = 7 \text{ m} \rightarrow 3 \text{ m}$ )
- Single beam aperture measurements
- Single beam size measurements
- Explore better sextupole configuration
- "Knocker study" for confirming upside-down pipes

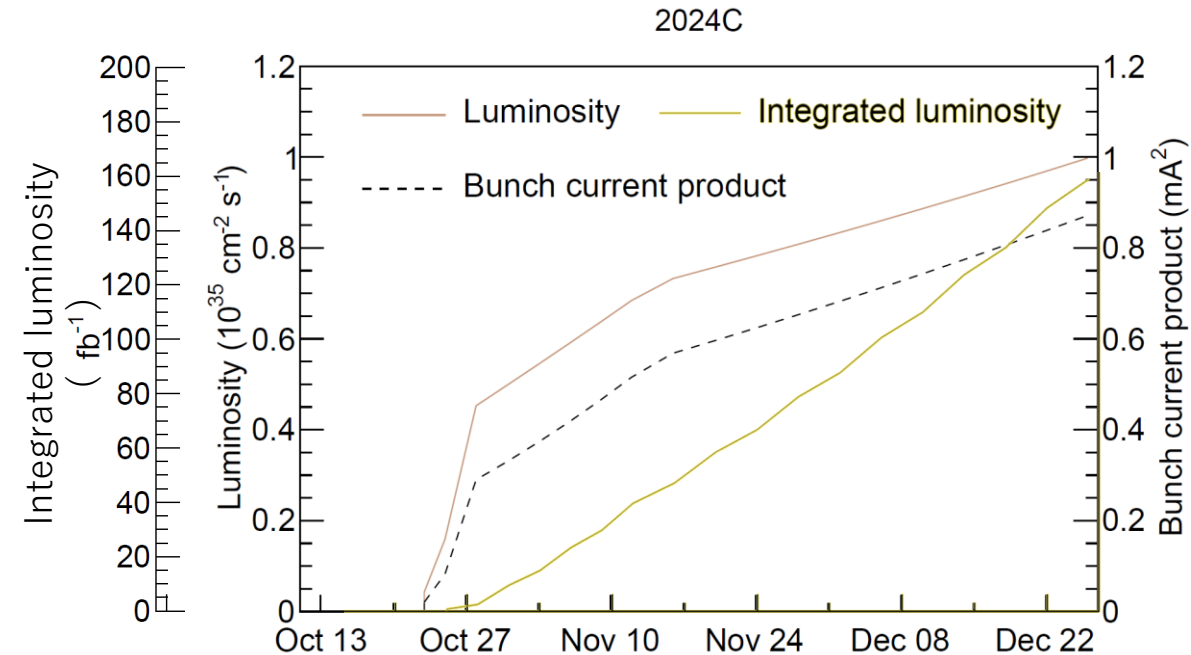
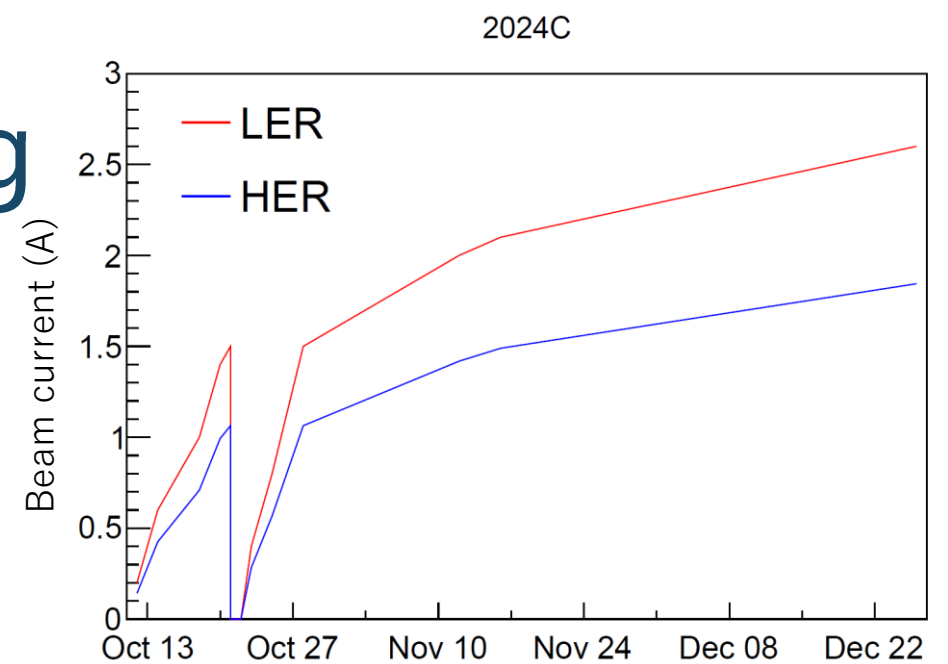

# Physics run

- **21 Oct. – 27 Dec. (under discussion)**

- $\beta_y^*$  squeezing
  - Detuned  $\rightarrow$  0.9 mm (no intermediate step)
- Beam current
  - Increase the beam current as quickly as possible
  - Establish 2024b's highest beam current after collision
    - 1.2 A in HER / 1.5 A in LER
- Beam-beam effect-induced injection efficiency degradation needs to be solved to reach a higher beam current than 2024ab.

- **Study items (# beam-beam related studies)**

- Linac-BT tuning, ML-assisted orbit tuning
- Changing  $\beta_x$  at the injection region<sup>#</sup>
- betatron tune scan<sup>#</sup> (finding better operation point)
- Changing  $\beta_x$  at the interaction region<sup>#</sup>
- Explore better sextupole configuration
- "Knocker study" for confirming upside-down pipes
- (Synchrotron injection)
- ( $\beta_y^*$  0.9 mm  $\rightarrow$  0.8 mm)

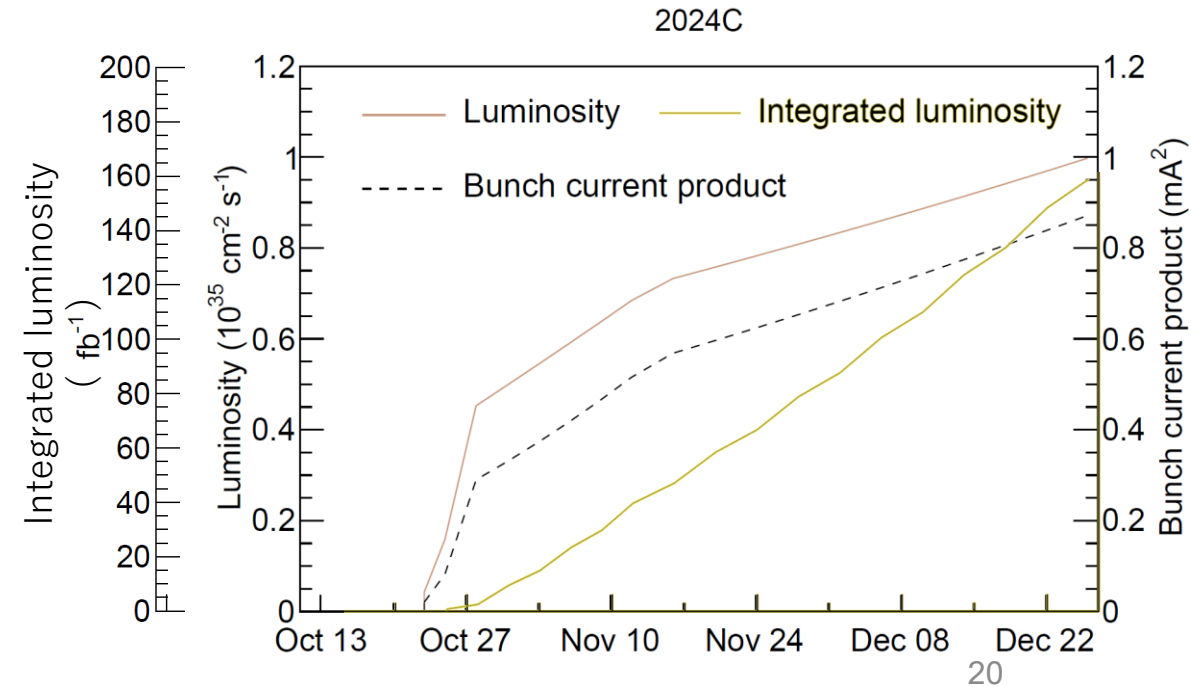
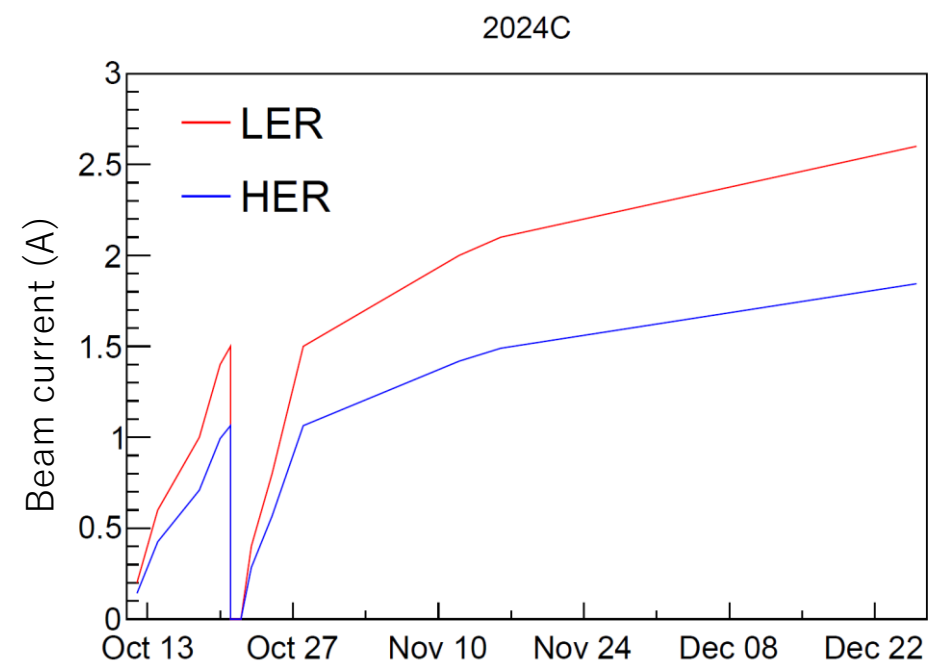

# Towards HER/LER = 1.8/2.6 A

- **Stable 2-bunch injection is necessary for 1.8/2.6 A**

- Fast kickers at Linac and RTL are allocated to correct 2<sup>nd</sup> bunch orbit.
- The number of injection-induced beam aborts will be reduced thanks to the relaxed threshold of the VXD diamond sensors.
- 1<sup>st</sup> and 2<sup>nd</sup> e+ bunch charges will be increased from 3nC to 4nC at the BT end.

- **Mitigation of the beam-beam interaction effects**

- Injection efficiency degradation occurs due to beam-beam Interaction effects at high bunch current.
- Larger  $\beta_x$  at the injection region is applied after collisions.
- Synchrotron injection scheme is another option.
- Lower betatron tune will improve injection efficiency.

- **Precise measurement of injection orbit and correction**

- HER injection efficiency was improved significantly during the last two weeks of the 2024ab run.
- Fine optics matching between MR and BT
- RF kickers and vertical kickers are ready in both rings.

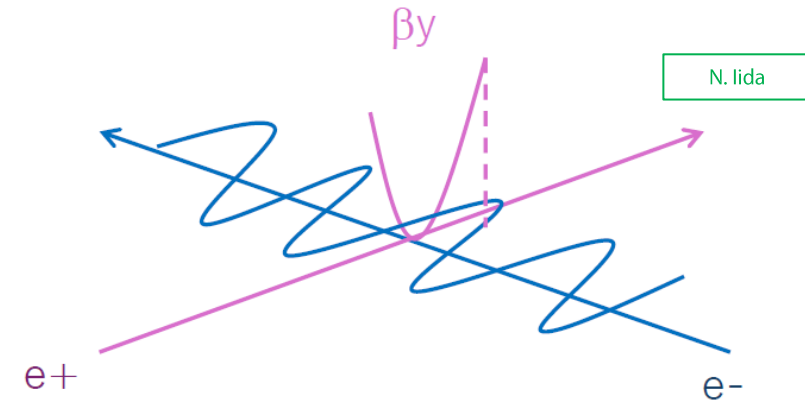

If the injection e- beam has a large horizontal oscillation amplitude, it will collide with e+ beam at the collision point where the  $\beta_y$  of e+ beam is large and the beam will be unstable.

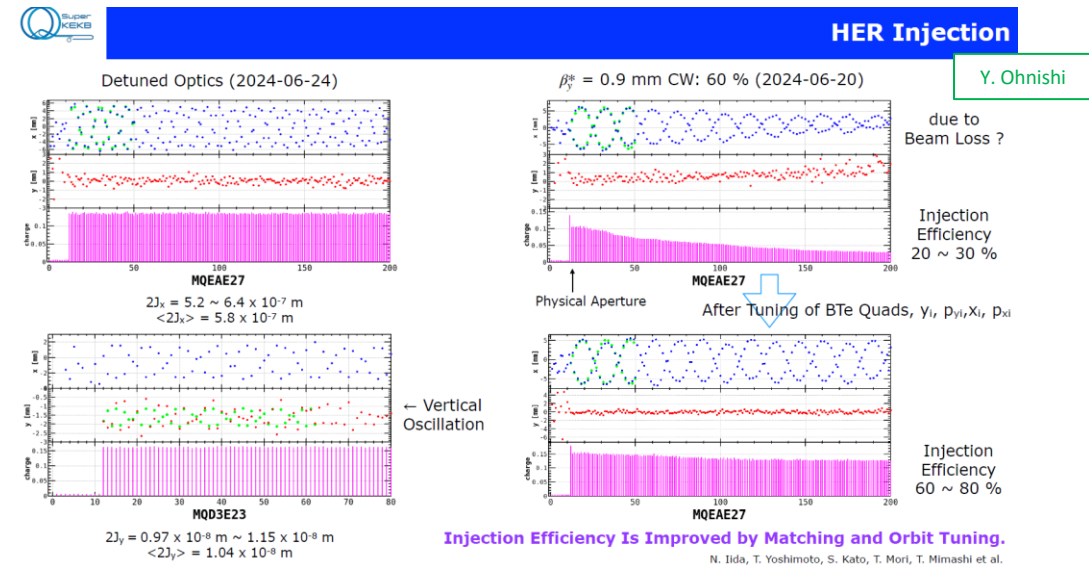

# Mitigation of beam size blowup/beam oscillation

- **Bunch-by-bunch FB and vertical tune need optimization.**
- **Further optimization of nonlinear collimator**
  - Currently, NLC can reduce stored beam BG, but not enough for injection beam BG.
  - Nevertheless, changing the  $\beta_x$  at the skew sextupole magnets from 7 m to 3 m will reduce injection beam BG.
  - If we can utilize a nonlinear collimator instead of the arc collimator D06V1, the impedance can be reduced significantly.

LER, 2024b (27 Jun. 2024)

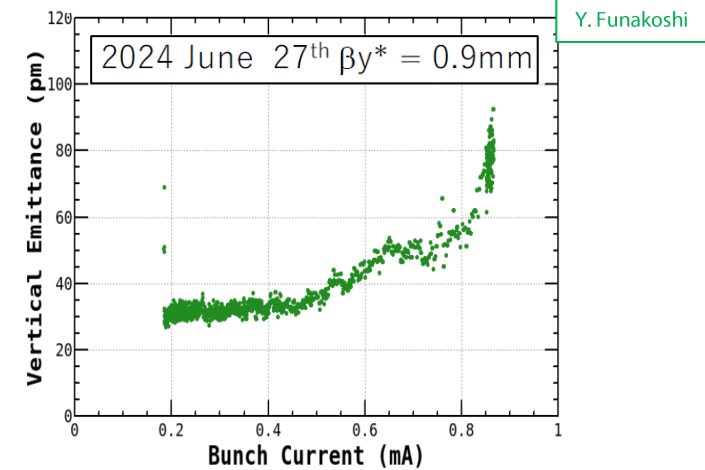

LER, 2022ab (Mar. & Jun. 2022)

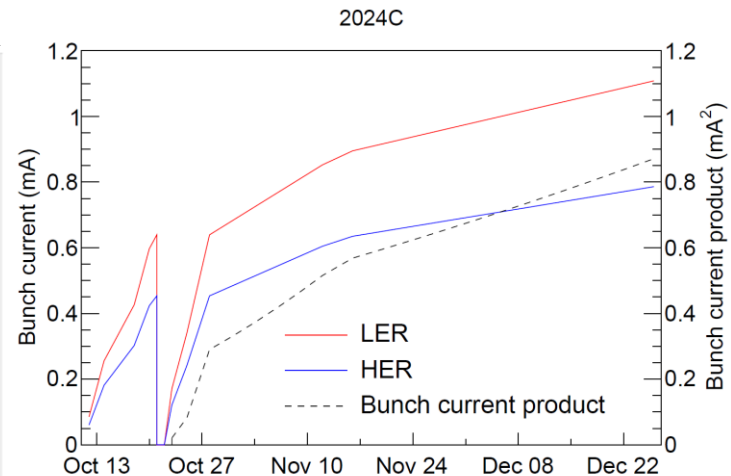
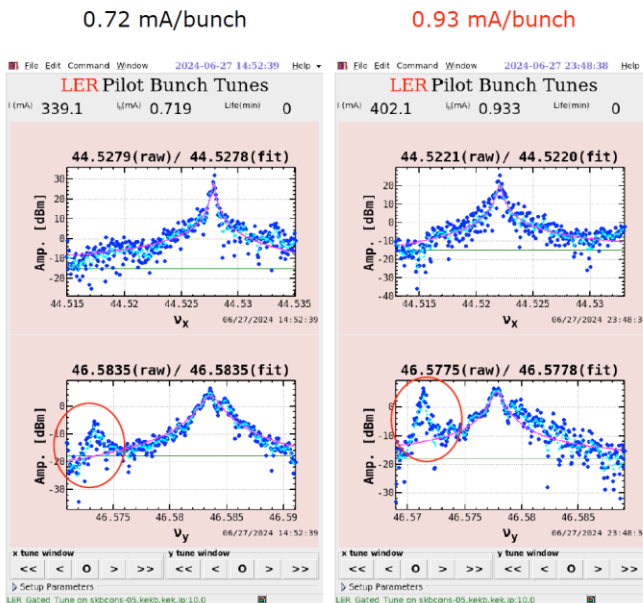
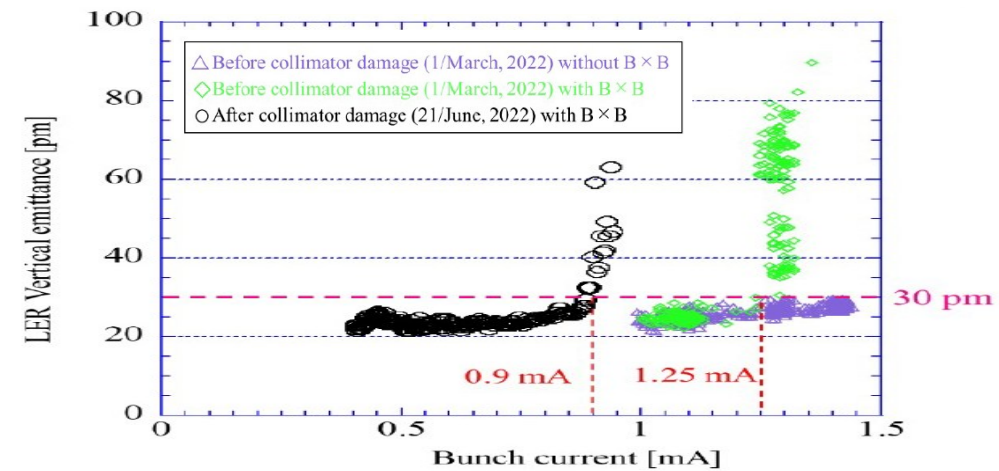

# Summary

- **Highlights from 2024ab operation**

- Peak luminosity:  $4.47 \times 10^{34} \text{ cm}^{-2}\text{s}^{-1}$ 
  - $L_{\text{sp}} = 5.9 \times 10^{31} \text{ cm}^{-2}\text{s}^{-1}/\text{mA}^2$ ,  $\beta_y^* = 0.9 \text{ m}$ , HER/LER = 1180mA/1450mA, 2249 bunches
- Struggling with SBL and increasing beam current more than 1.5 A/1.2A (LER/HER)
  - New findings during the 2024ab run suggest that dust at wiggler sections is the most likely cause of SBL at LER.
  - Injection efficiency degradation occurs in LER due to the Beam-Beam interaction effect at high bunch current.
- Nonlinear collimator demonstrated its ability reduce stored beam BG with lower impedance.

- **Major work during the summer shutdown**

- Most of the planned work were carried out as scheduled.
  - SBL countermeasure: turning beam pipes at the OHO straight section, beam pipe knocking
  - Injection improvement: beam diagnostics line at Linac, fast kickers at Linac, vertical kicker in MR LER, SRM at BT.
  - Others: damaged collimator replacement, LER Inj. Kicker trigger system improvement, New BPM support for isolating Q-mag and beam pipe, etc.
- Some delayed works, postponed until the winter, will not impact the 2024c run.

- **2024c operation schedule**

- MR beam operation: 9 Oct. – 27 Dec. (expected)
  - The budget for MR operation until the end of November has been secured.
  - We are trying to get the budget for MR operation in December.
- Increasing the beam currents keeping  $\beta_y^*$  at 0.9 mm to aim at  $1 \times 10^{35} \text{ cm}^{-2}\text{s}^{-1}$ .

# Backup



# 高速パルスキッカー補足

	場所	
FY_A2_2	Aセクター	2024夏に導入
FY_A4_4	Aセクター	2024夏に導入
FY_R0_02	J-Arc入口	プロトタイプ。電源の立ち上がりが遅い。 キック量を大きくする場合は1stバンチも蹴る必要あり。 2ndのみキックの場合はキック量が小さい。 電源交換で他と同様に動作可能。
FY_58_4	5セクター最下流	タイミングジッター
FY_61_E	SY3	放射線損傷で電源故障。電源修理済で新規設置場所検討中。

電源はタイミングのジッターがあり、ノイズが原因と考えられる。  
調査、対応を検討中。

秋の運転で2バンチ目キックの揺らぎの大きさを測定し、運転での利用を試みる。

# パルス電磁石用制御システムの改善

- 2017年夏期保守期間中，3-5セクタ全電磁石パルス化のさい，WindowsPC/LabVIEW/NI PXI基盤の制御システム17台を導入した。（榎本Y氏）
- 停止の頻度が高く（2023cでは28回停止），停止時のシステム再立ち上げに時間がかかる（約7分）．このため，LinuxPC/EPICS IOC基盤の新制御ソフトウェアを構築し，LS1期間中に8台を新システムに入れ替えた．今夏期保守期間中に残りの箇所も新システムに入れ替える．
- 2024a, bでの停止は8回にとどまった．（停止した箇所はすべて旧システム）
- 新システムは，現在まで停止したことはない．



## Hardware

- PCIe-8381 & PXIe-8381, PXI Remote Control Module
- PXI 6733 DAC
- PXIe 6356 ADC
- MRF EVR-230

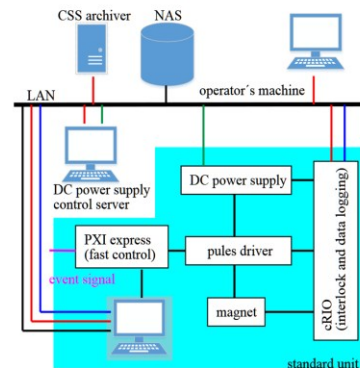

D. Wang

# 自動ビーム調整の導入

- 入射器において、ベイズ最適化(またはdownhill simplex)による自動調整試験を2022年10月から開始した。(T. Natsui, G. Mitsuka, S. Kato)
- 陽電子生成量, ビーム通過効率向上(2セクタ終端まで)を目的として, 現在では同時に16パラメタ(パルスステアリング, RF位相)を調整する手法を確立した。(運転員が調整可能)
- 2バンチ調整, ディスパージョン補正に応用(T. Natsui)
- 入射調整に応用(G. Mitsuka, S. Kato)

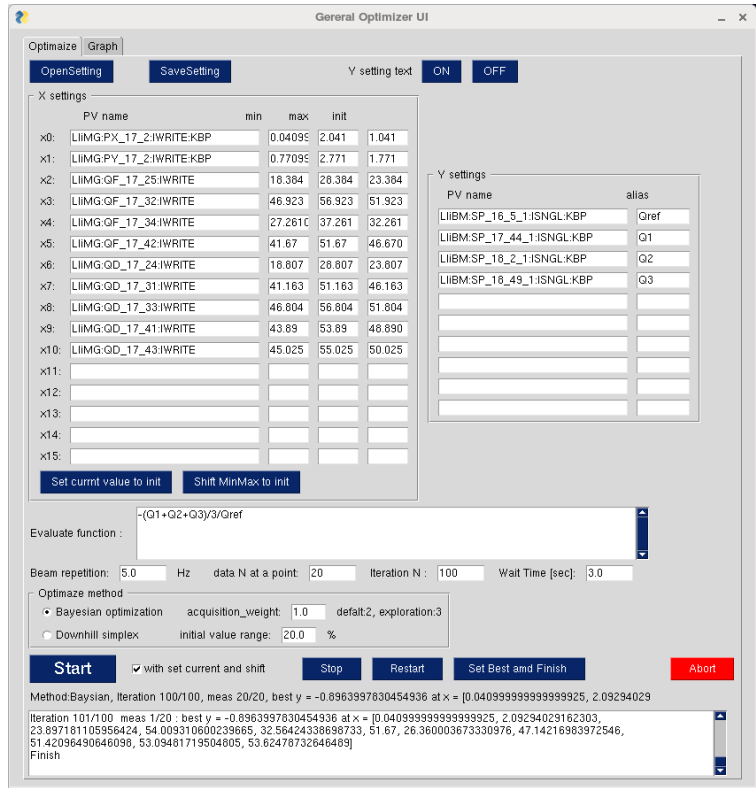

自動調整OPI

T. Natsui

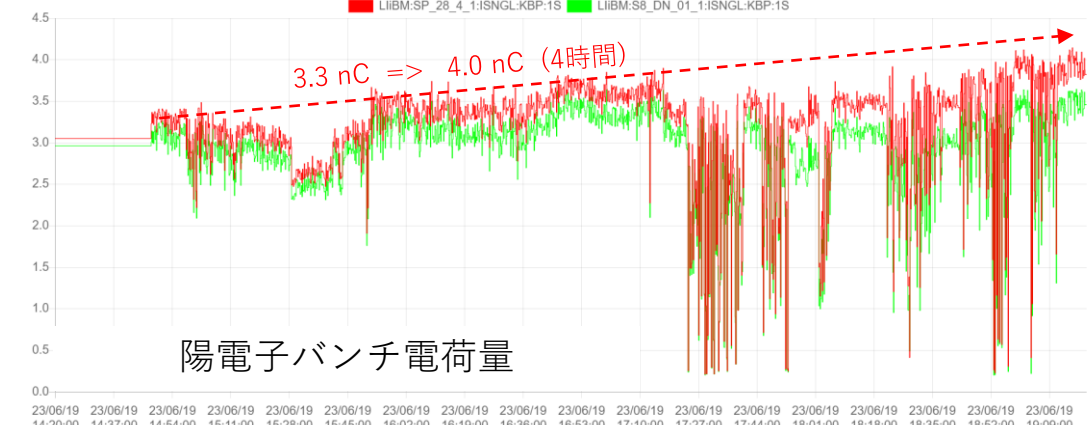
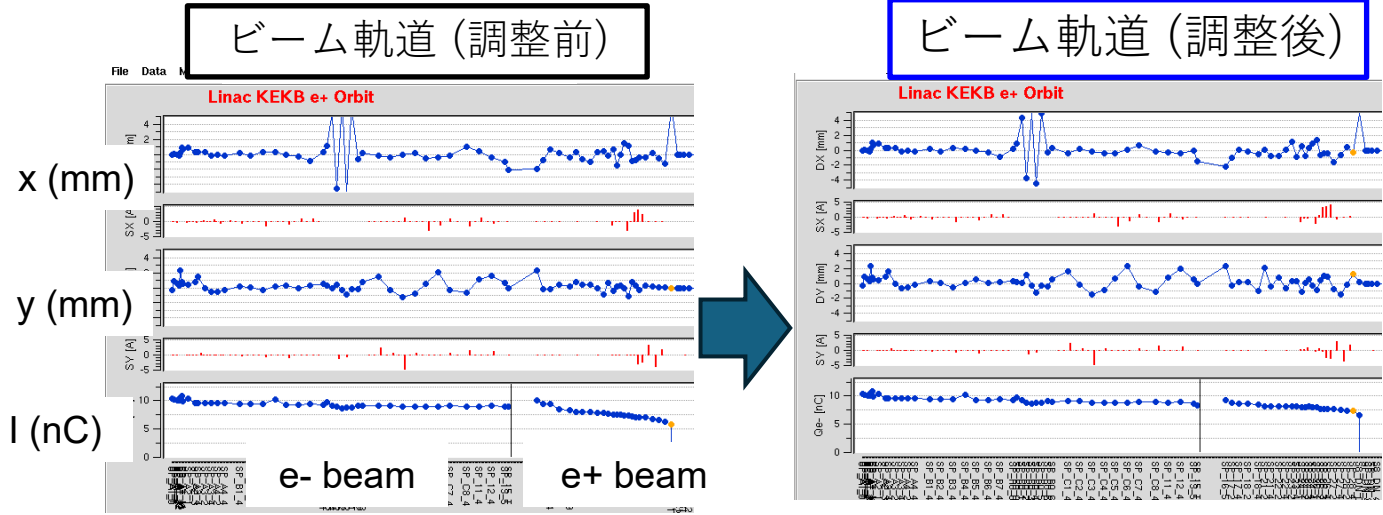

陽電子バンチ電荷量

e-

e+

# Ring acceptanceと入射粒子の広がりと対策

N. Iida

HER $\beta_y^*=1\text{mm}$ CW 40%	$2J_x$ [ $\mu\text{m}$ ]	$2J_y$ [ $\mu\text{m}$ ]	$\Delta p/p_0$ [%]
HER simulation(Y. Ohnishi)	2.77	973	1.07
HER measurement	1.13 $\beta_x=160\text{m}$	712 $\leftarrow 9\epsilon_{iy}=\text{Equivalent to } 79\mu\text{m}$	0.69
Injection measurement	1.11 $\rightarrow$ 0.93	$9\epsilon_y=3263, 1080$	0.35 (simulation)
Countermeasure	Smaller injection oscillation (Ex. $\beta_x=100 \rightarrow 160\text{m}$ )	Expect some improvement with BTe Arc1 vertical bump 12mm	ECS further reduces the tail after the next summer.

LER $\beta_y^*=1\text{mm}$ CW 80%	$2J_x$ [ $\mu\text{m}$ ]	$2J_y$ [ $\mu\text{m}$ ]	$\Delta p/p_0$ [%]
LER simulation(Y. Ohnishi)	3.37	?	1.11
LER measurement	0.90 $\beta_x=160\text{m}$	To be measured in 2024c	0.61
Injection measurement	1.41 $\rightarrow$ 1.17	$9\epsilon_y=196.7$	0.32 (simulation)
Countermeasure	Smaller injection oscillation (Ex. $\beta_x=100 \rightarrow 160\text{m}$ )	LER V. kicker makes LER acceptance measurement clear.	

# Injections in 2024ab

“Raw injection efficiency” means an efficiency 100 turns after the injection

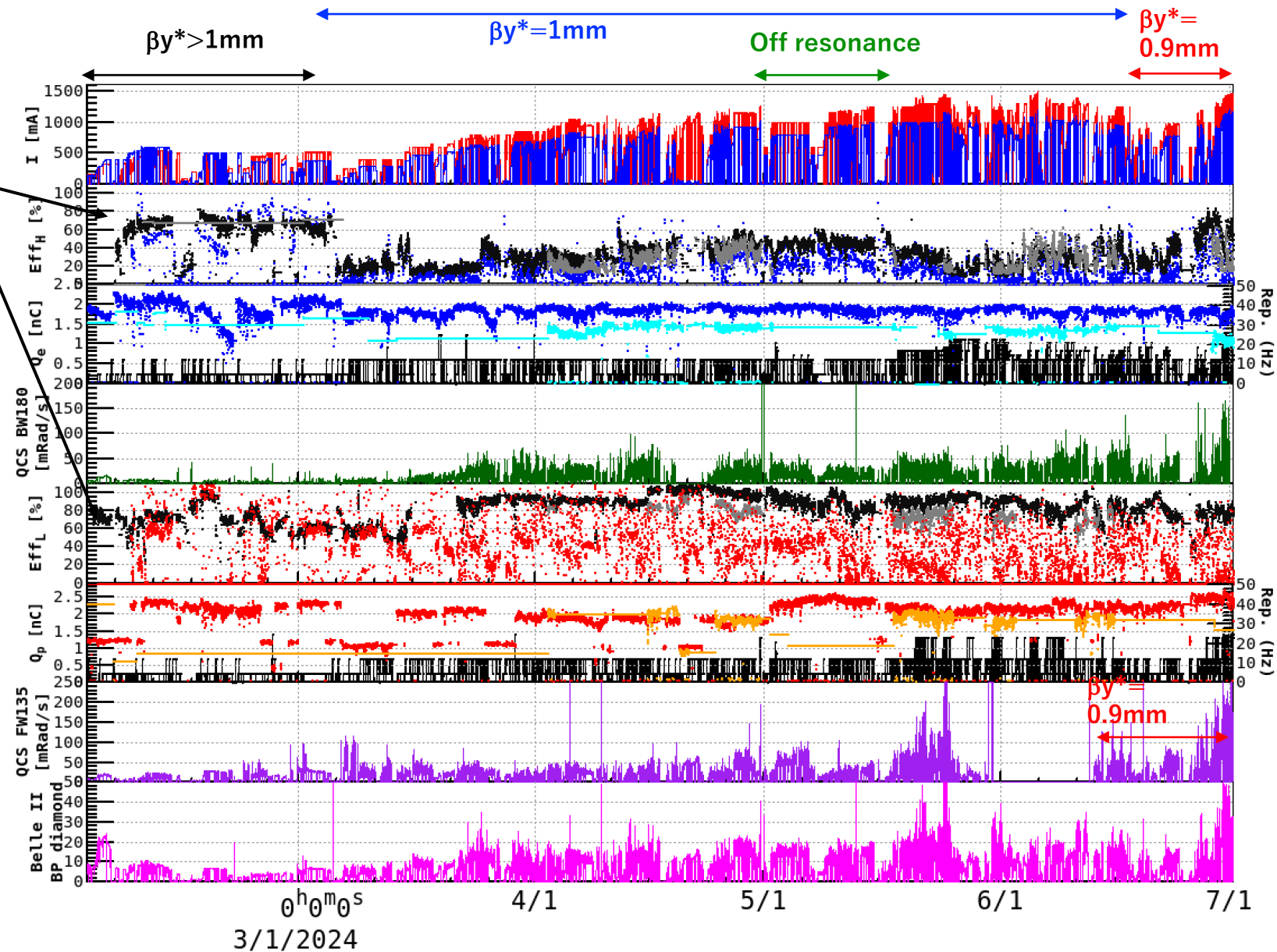

# Measured emittance

$\gamma_{eX} \sim 150 \mu\text{m}$   
 $\gamma_{eY} \sim 10 \sim 20 \mu\text{m}$

$\gamma_{eX} \sim \gamma_{eY} \sim 30 \sim 70 \mu\text{m}$

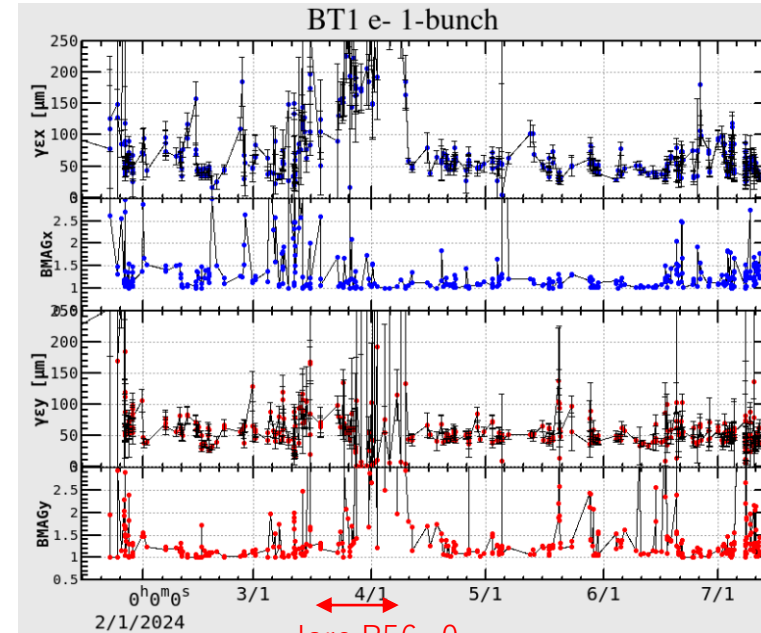
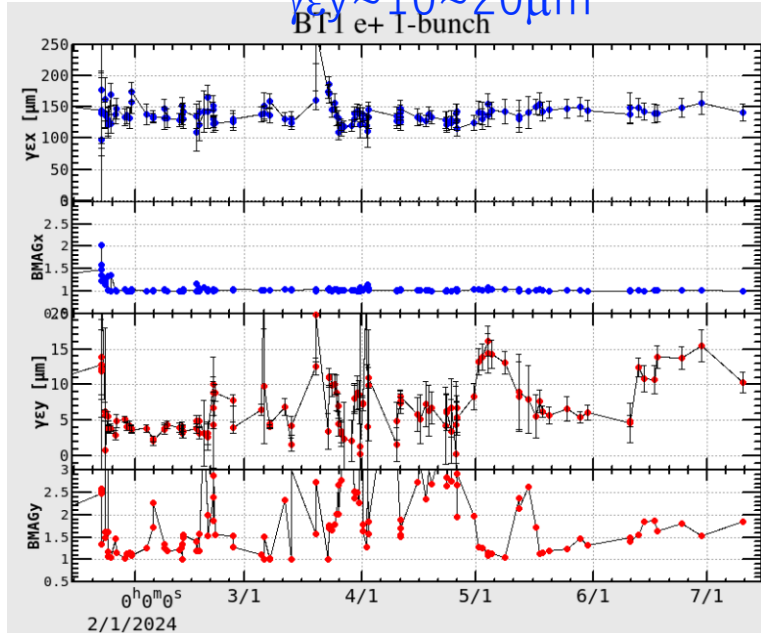
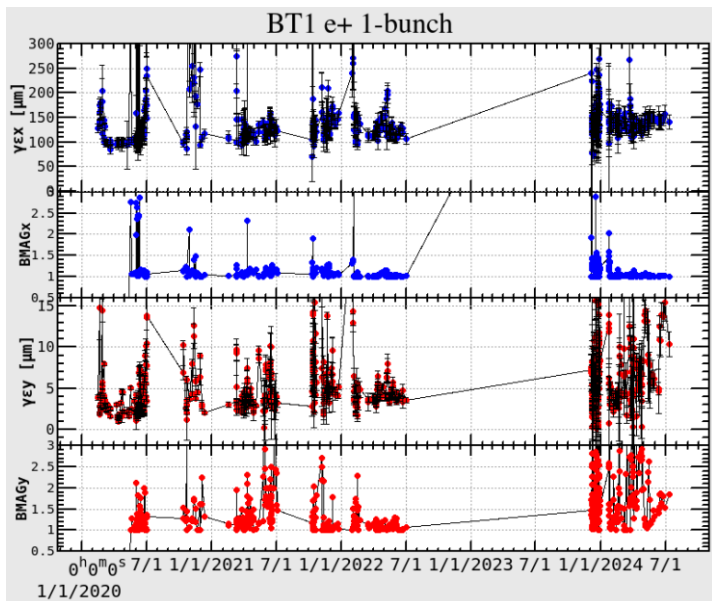

e+の水平エミッタンスが  
 2022より悪化している。  
 次回、RTLのQuadを2022  
 年に戻してみたい。

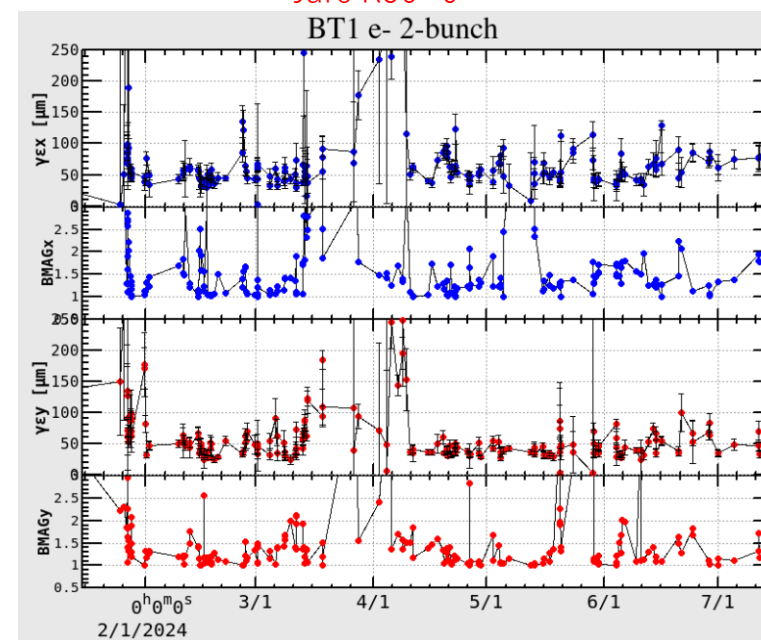
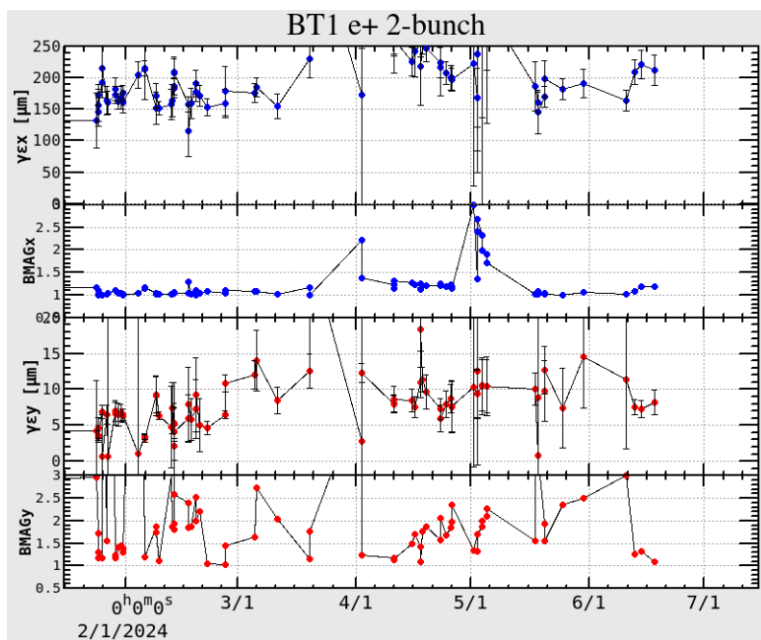

# BT

2 nC

- Emittance blowup
  - Both horizontal and vertical are increasing within BT.
- ① Horizontal
  - Incoherent synchrotron radiation (ISR) can explain  $\sim 40\mu\text{m}$
  - The remaining  $60\mu\text{m}$  in CSR cannot be explained at present. (A2)
- ② Vertical
  - In the July study, a 12mm vertical bump was made in BT Arc1, and the measurement upstream of Arc2 showed that the dispersion (almost 0) and vertical emittance were reduced to a certain extent (2/3). (A2)
  - The simulation will be done by Y. Shimosaki.

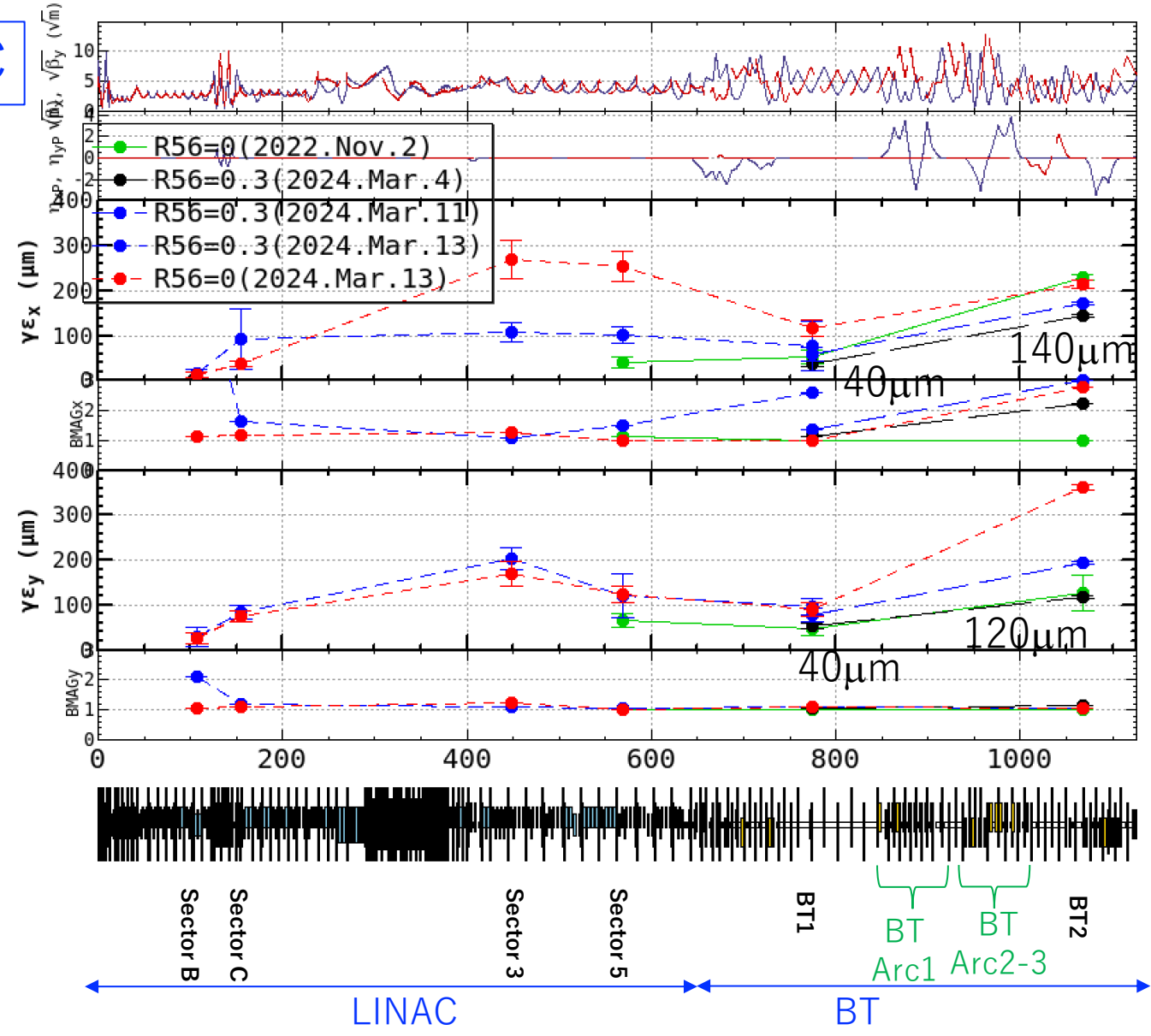



# BT

## • Emittance blowup

### ① Horizontal

- **Mainly occurs in the second arc of RTL**
- In 2022, it was  $120\mu\text{m}$ . We will try going back to that parameter.

### ② Vertical

- **Mainly occurs in BT1~BT2.**
- The 2023-24 BT e+ Study reproduced this in a tracking simulation that included the multipole components of the bend in BT Arc3.
- How large is it compared to the current LER dynamic aperture (DA) ?

Table 1: Emittance Measurement and Simulation in BT

	Measured BT1	Measured BT2	Simulation
$\gamma\epsilon_x [\mu\text{m}]$	130	$175\pm 10$	160
$\gamma\epsilon_y [\mu\text{m}]$	5	$20\pm 1$	17

Annual Meeting of the Particle Accelerator Society of Japan, 2024.8, THP025, N. Iida

The magnetic field calculations and orbits of the bends of Arc2 and 3 are reflected in the tracking simulation in detail(K. Oide).

→ The increase in emittance was reproduced!

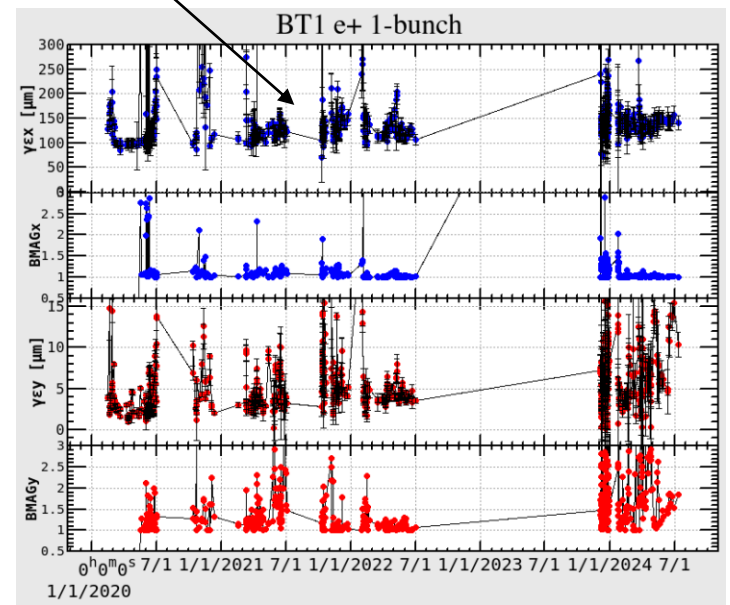
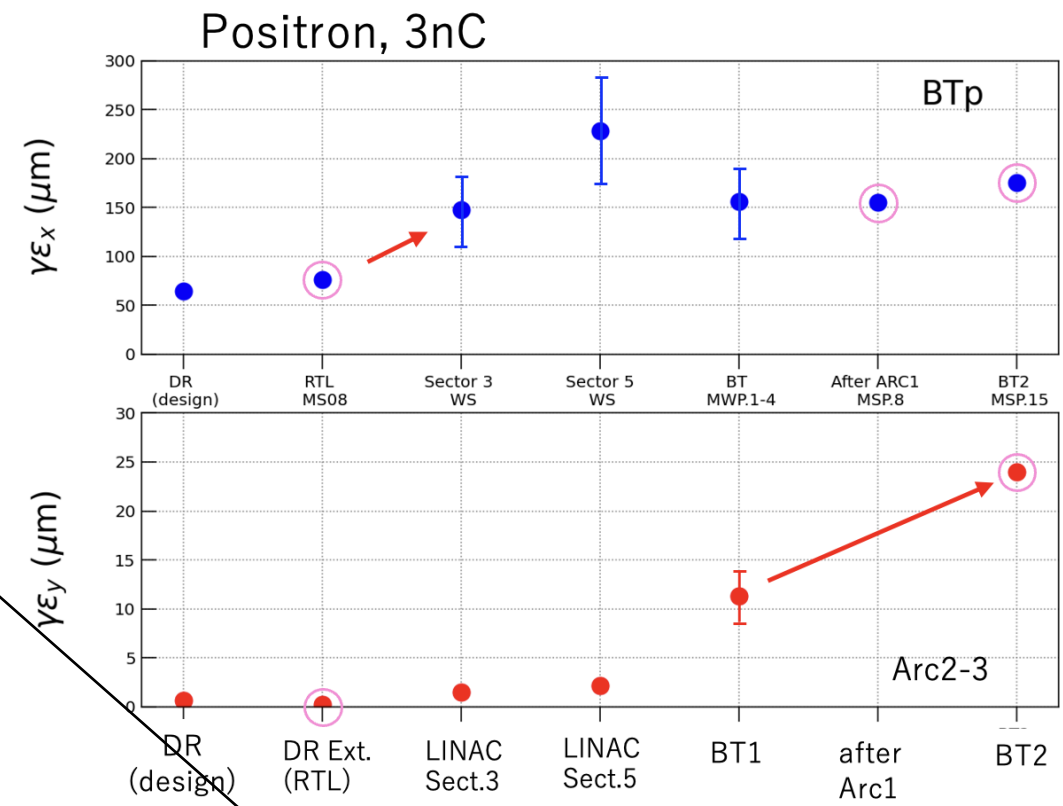



# Improvement plan in 2024c

## Charge

- Both of 1<sup>st</sup> and 2<sup>nd</sup> e+ bunches increased from 3nC to 4nC at the end of BT!!!

## Vertical

- Vertical bump in the BTe Arc3 (A2)
  - The vertical emittance is expected to be smaller (~2/3).

## Horizontal

- Change  $\beta_x$  at the entrance point from 100m to 160m (A3)
  - Make lower injection oscillation
  - Planned to be tested at 2024c

## Horizontal

- Synchrotron injection
  - Details are shown in (A8~A10).
  - HER: Planned to be tested at 2024c.

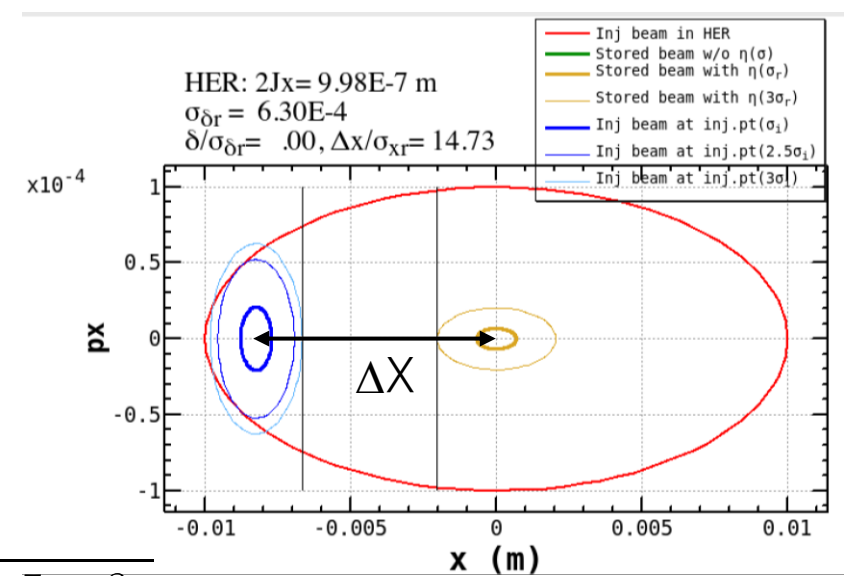

$$\Delta X = \sqrt{2J_{Xc}\beta_x}$$

### Betatron injection

By increasing  $\beta_x$  at the incident point, the injection oscillation ( $2J_{Xc}$ ) can be reduced even if ( $\Delta X$ ) at the injection point is the same.

$$\Delta X = \Delta\delta\eta_x + \sqrt{2J_{Xc}\beta_x}$$

### Synchrotron injection

If the incident beam is set to  $hx$  at the entrance of the ring, then for the incident beam of  $\Delta\delta = \Delta X / \eta_x$ ,  $\Delta X = \Delta\delta\eta_x$ , and  $\sqrt{2J_{Xc}\beta_x}$  can be made completely zero.

→ The horizontal injection oscillation disappears and it becomes the longitudinal oscillation.

### Synchro-beta injection

By setting  $\Delta\delta < \Delta X / \eta_x$ , the ratio of horizontal and longitudinal oscillation can be changed.

# HER Inj. Efficiency Improvement Measures #2

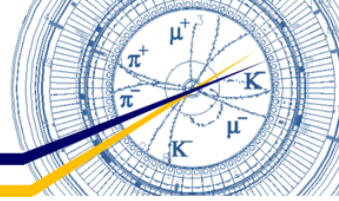

- Two more fast-kickers for orbit collection of electron 2<sup>nd</sup> bunch at Linac
  - Vertical orbit change at Linac causes HER injection efficiency reduction.
    - Vertical orbit correction at A-sector can improve injection efficiency.
  - Two more fast-kickers were installed for 2<sup>nd</sup> bunch orbit correction at Linac A-sector (most upstream of Linac).
    - It has been demonstrated that the fast-kickers correct the vertical orbit of only the 2<sup>nd</sup> bunch.

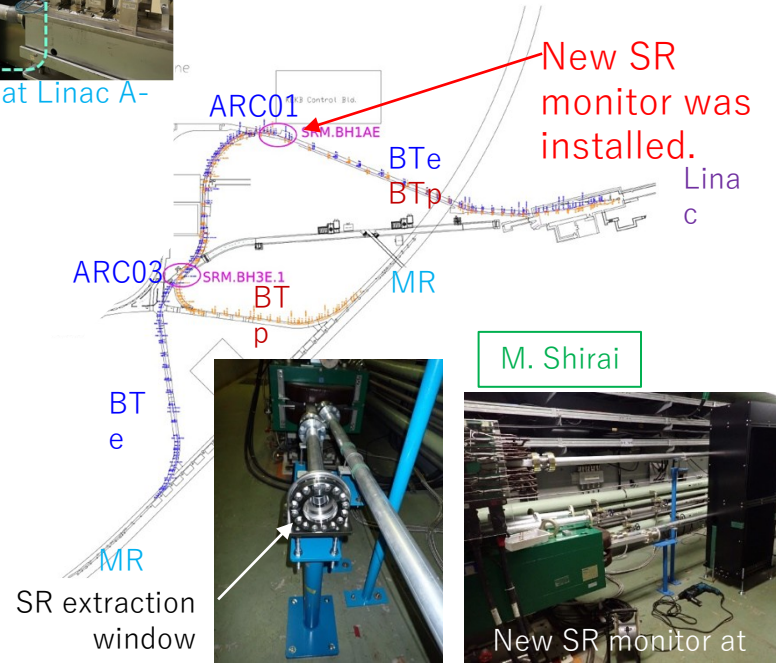
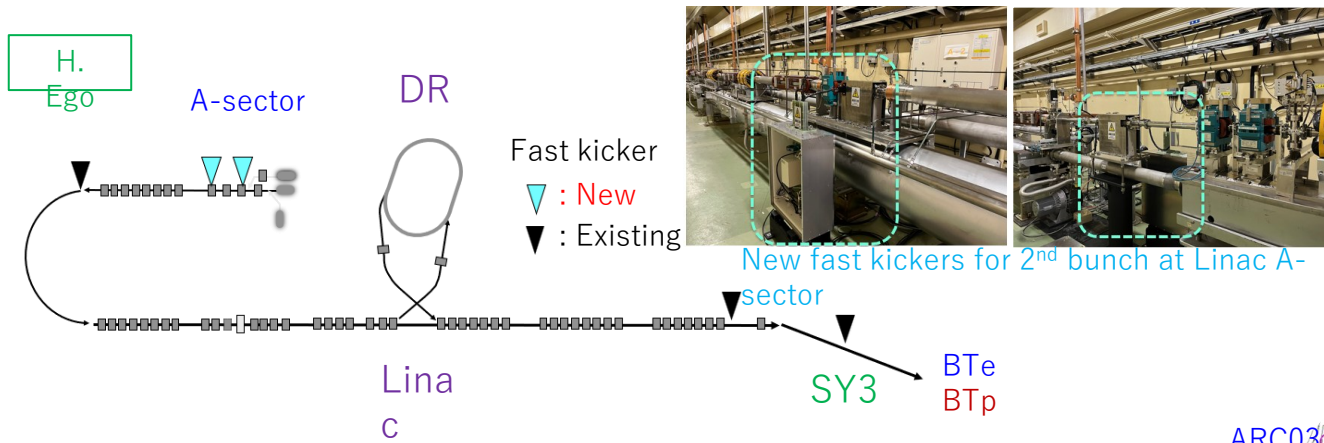
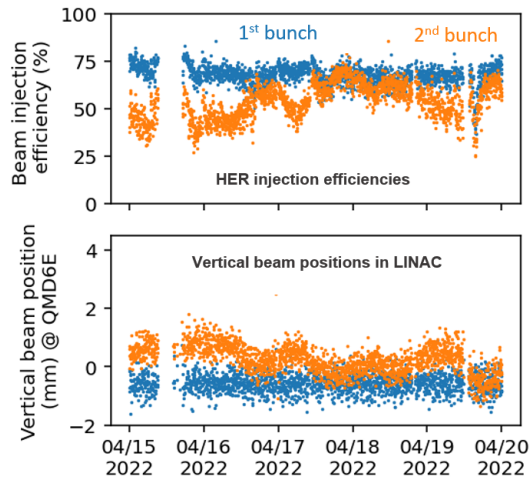

- New SR monitor for beam diagnostics at ARC01 of BTe
  - New SR monitor was installed at ARC01 of BTe.
  - There is an existing SR monitor at ARC03.
  - Two SR monitors make it possible to diagnostic electron beam at BT more precisely while keeping beam injection.

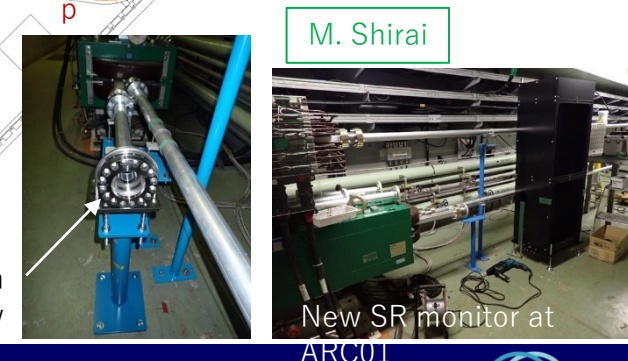

# Luminosity

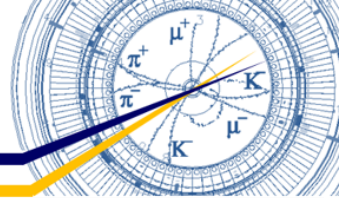

- Peak luminosity  $L_p = 4.47 \times 10^{34} \text{ cm}^{-2}\text{s}^{-1}$ 
  - Specific luminosity  $L_{sp} = 5.9 \times 10^{31} \text{ cm}^{-2}\text{s}^{-1}/\text{mA}^2$
  - $\beta_y^* = 0.9 \text{ mm}$
  - Beam current : HER/LER = 1180/1450
  - Number of bunches : 2249
  - Bunch current product ( $I_{b+} I_{b-}$ ) :  $0.338 \text{ mA}^2$
  - Crab waist ratio : HER/LER = 60/80 %

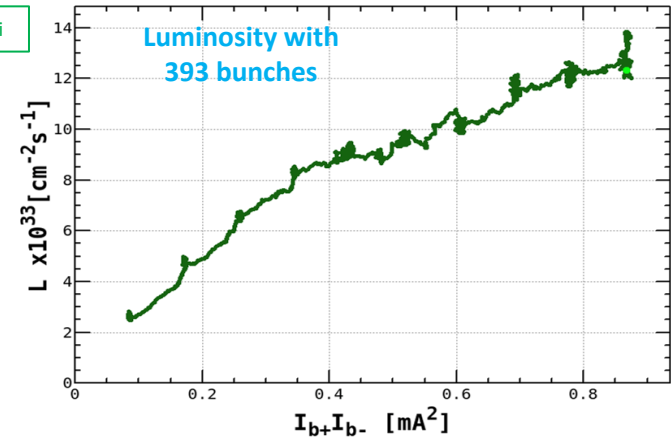
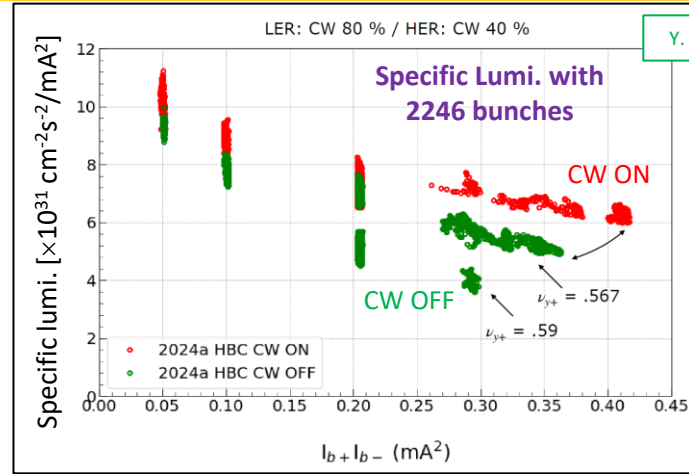

## Findings from Beam-Beam Study & High Bunch Current Study

- Crab waist is effective to increase luminosity and  $I_{b+} I_{b-}$
- Single beam vertical blowup was observed over 0.5 mA/bunch in both rings.
- LER vertical blowup due to Beam-Beam effect was observed
- Lowering horizontal tune improves LER injection efficiency and helps to increase beam current.
- $L_p$  reached  $1.38 \times 10^{34} \text{ cm}^{-2}\text{s}^{-1}$  with 393 bunches

## Outlook for 2024c run

- Increase total current (number of bunches) :
 
$$L_p = 1.38 \times 10^{34} \text{ cm}^{-2}\text{s}^{-1} \times 2346/393 = 8.27 \times 10^{34} \text{ cm}^{-2}\text{s}^{-1}$$
- Further  $\beta_y^*$  squeezing (0.8 mm) and increasing total beam current
 
$$\text{Target : } L_p = 1 \times 10^{35} \text{ cm}^{-2}\text{s}^{-1}$$

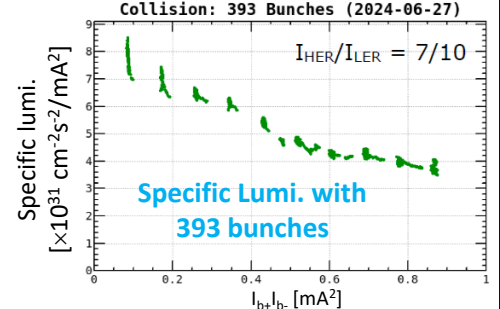
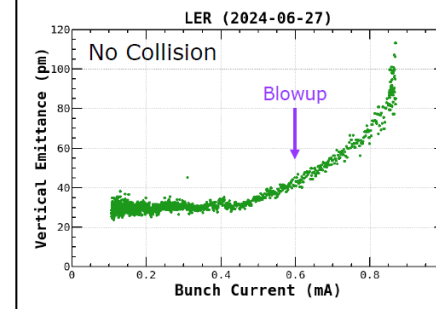
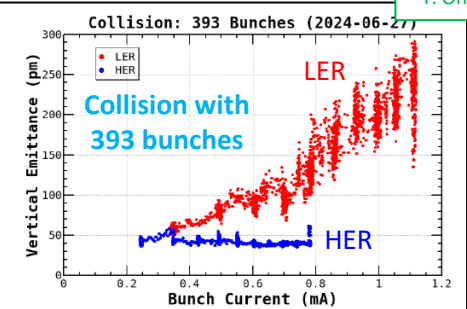
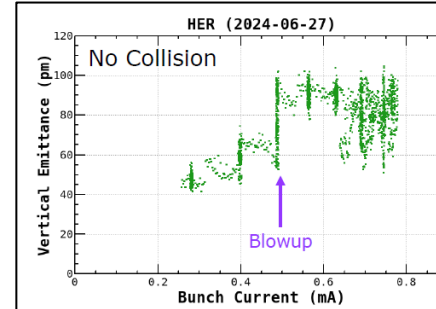

# Non-Linear Collimation (NLC) System

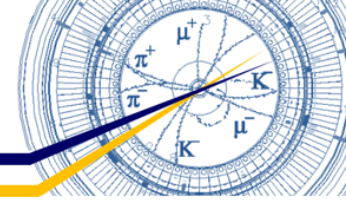

- Non-linear collimation (NLC) system was installed in LER Oho straight section.
  - Impedance of NLC is much lower than that of conventional collimator due to its large aperture.
  - NLC can relax TMCI bunch current limit.
  - Oho straight section is the location where the optics satisfies the requirements for NLC.
  - A part of wiggler magnets was removed to make space for NLC.
  - New skew sextupole magnets and beam pipes in them were fabricated.
  - New power supplies, cabling works and new radiation shields were also required.

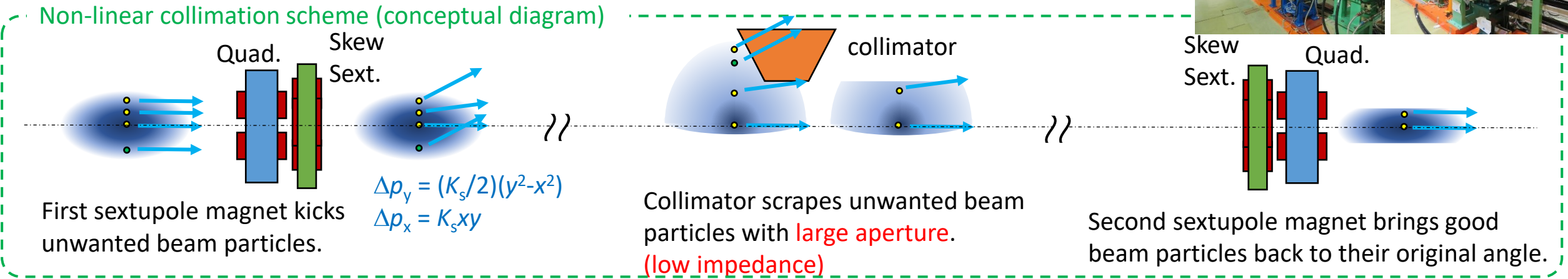
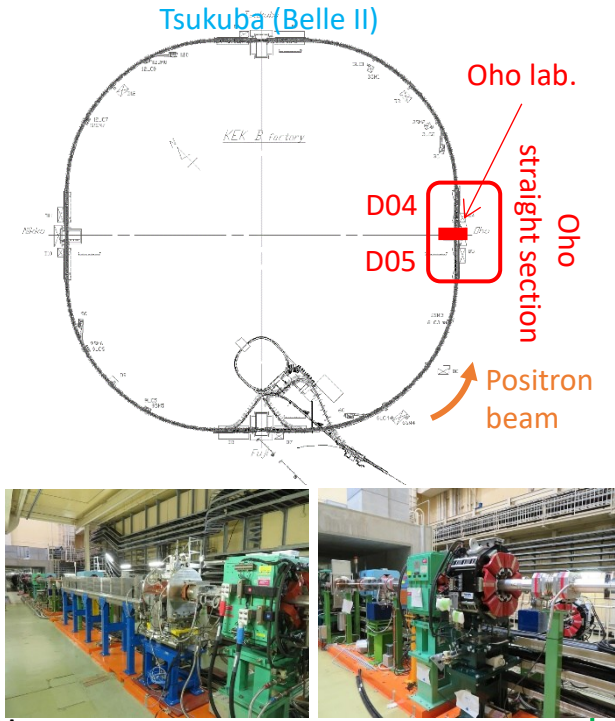
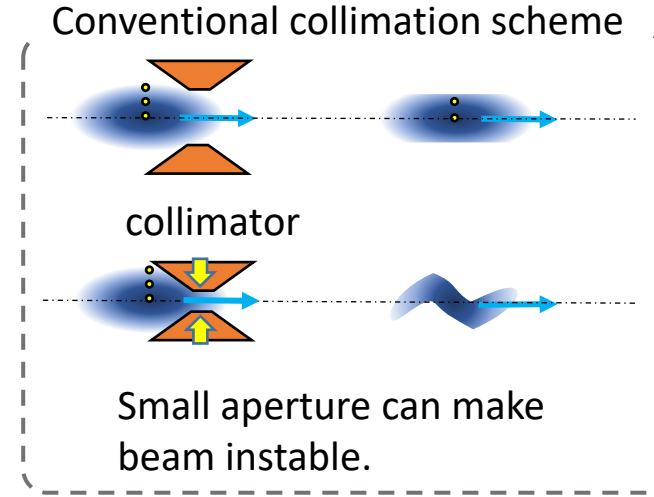

# First Trial of Non-Linear Collimator

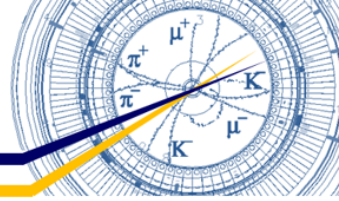

- Comparison between D05V1(NLC) and D06V1(Conventional type) with the same effective collimation gap
  - Storage beam B.G. : D05V1 suppressed more beam B.G. than D06V1
  - Beam lifetime : Very similar between D05V1 and D06V1
  - Beam blowup : No vertical blowup was observed with D05V1 (Suppression of beam instability (TMCI))
- Other findings :
  - Injection beam B.G. may also be reduced by NLC with tuning of  $\beta_x$  at the skew sextupole magnets.
    - It will be tested during 2024c run.
  - Radiation level in the Oho Experimental Hall increases as closing the D05V1 gap.
    - Though it was still lower than the regulatory limit, measures are required for future current increases.
    - During the summer shutdown, additional radiation shielding will be installed.

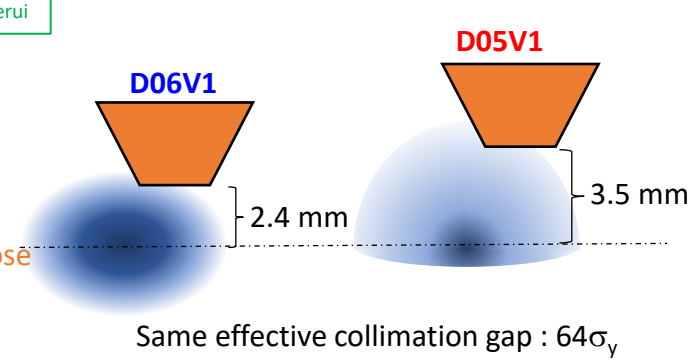
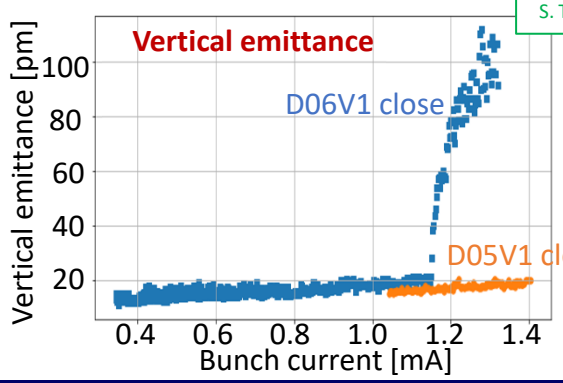
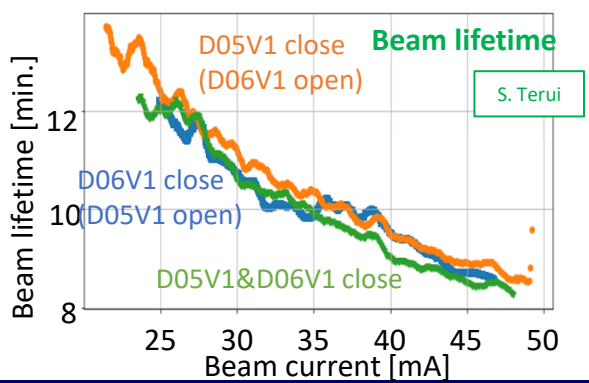
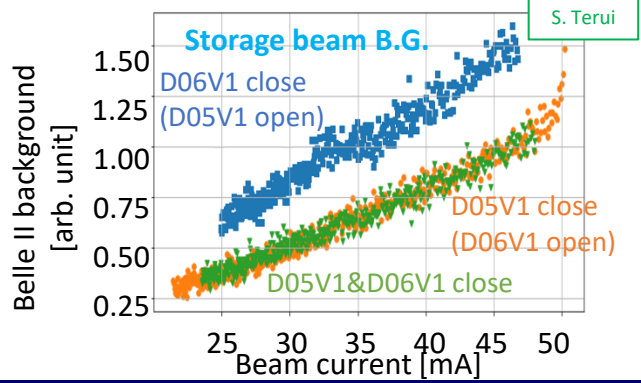
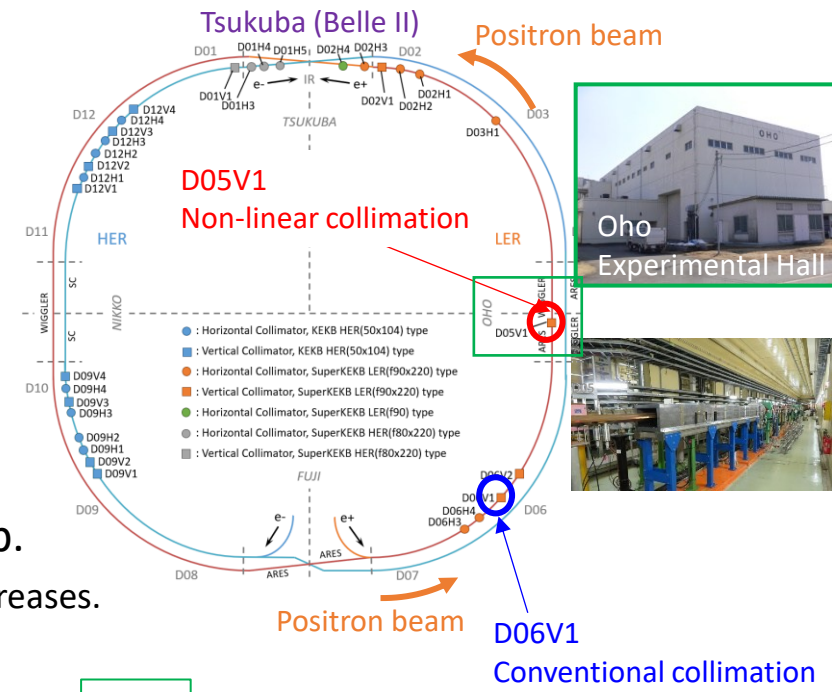

# SEM/EDS analysis of dust particles 1

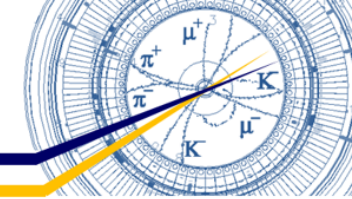

- Dust particles collected from beam pipes removed from D05 wiggler section for NLC construction
  - Small particles collected with tape
  - Main components : Fe, Al, O, C
  - Others : Si, Ni, Cu, Cr, etc.

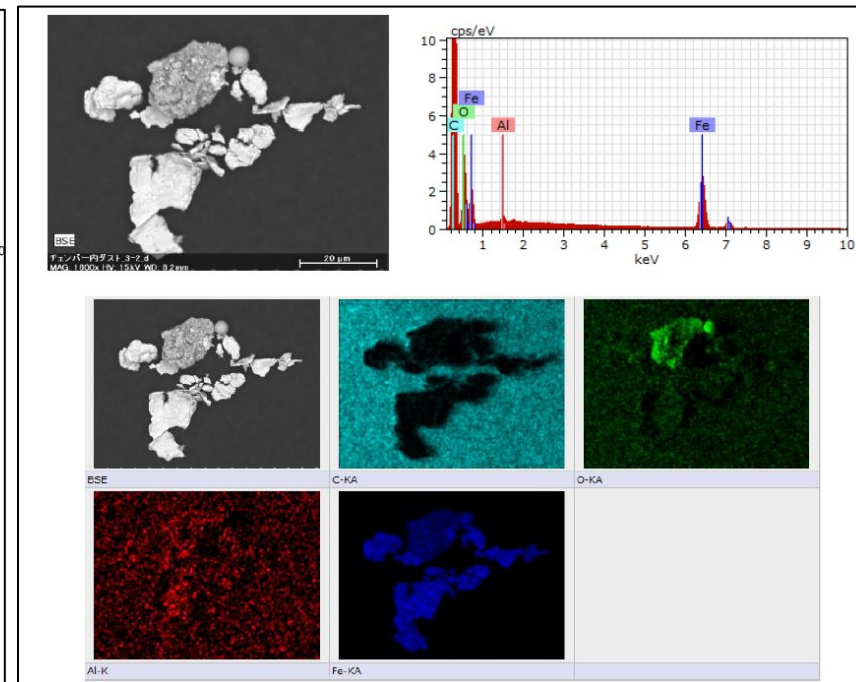
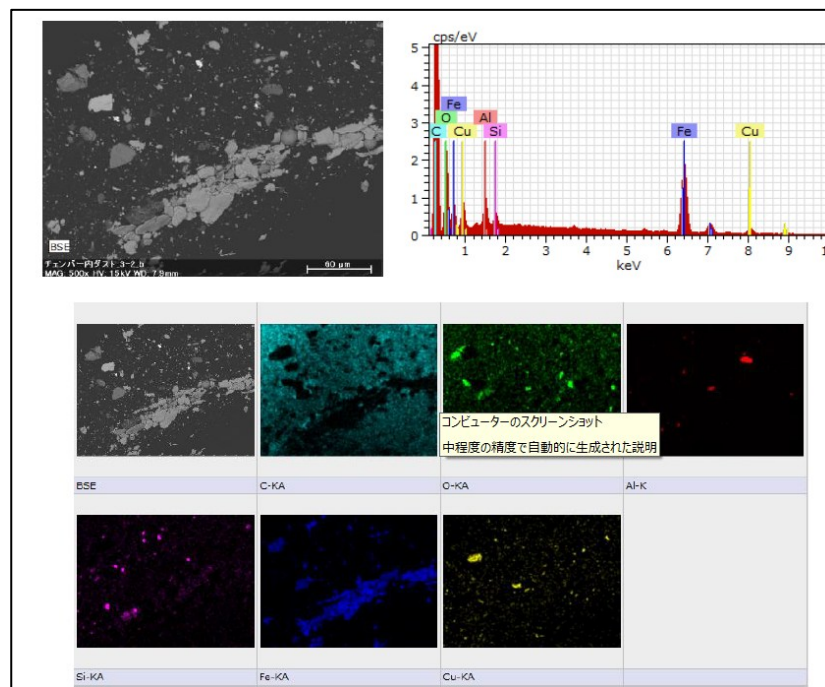
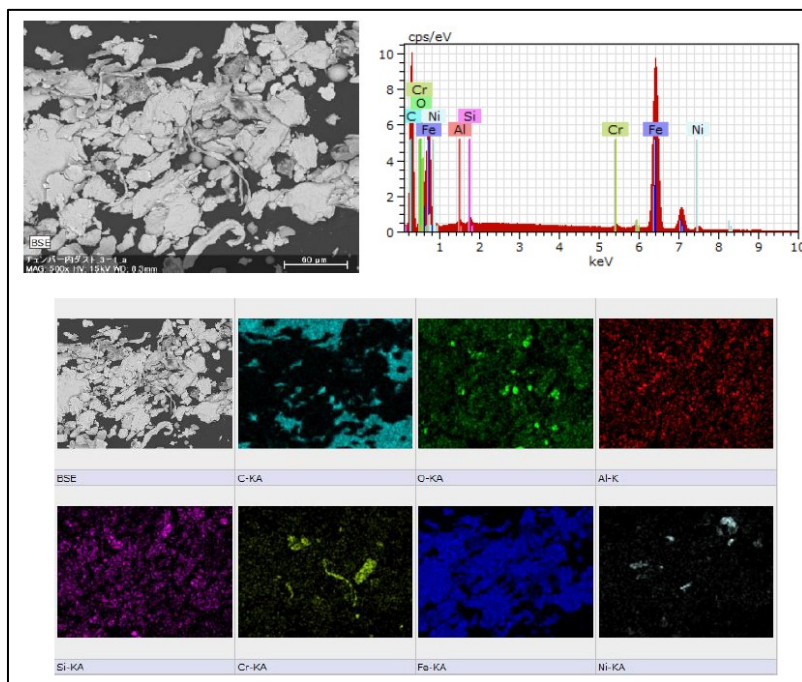

# SEM/EDS analysis of dust particles 2

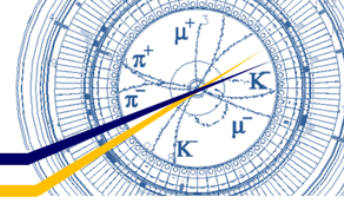

- Dust particles collected from beam pipes reinstalled in D05 NLC section
  - Large particles
  - Main components : O, Al, Si, Ca
  - Others : C, K, S, Mg, Ti, Cr, Fe, etc.

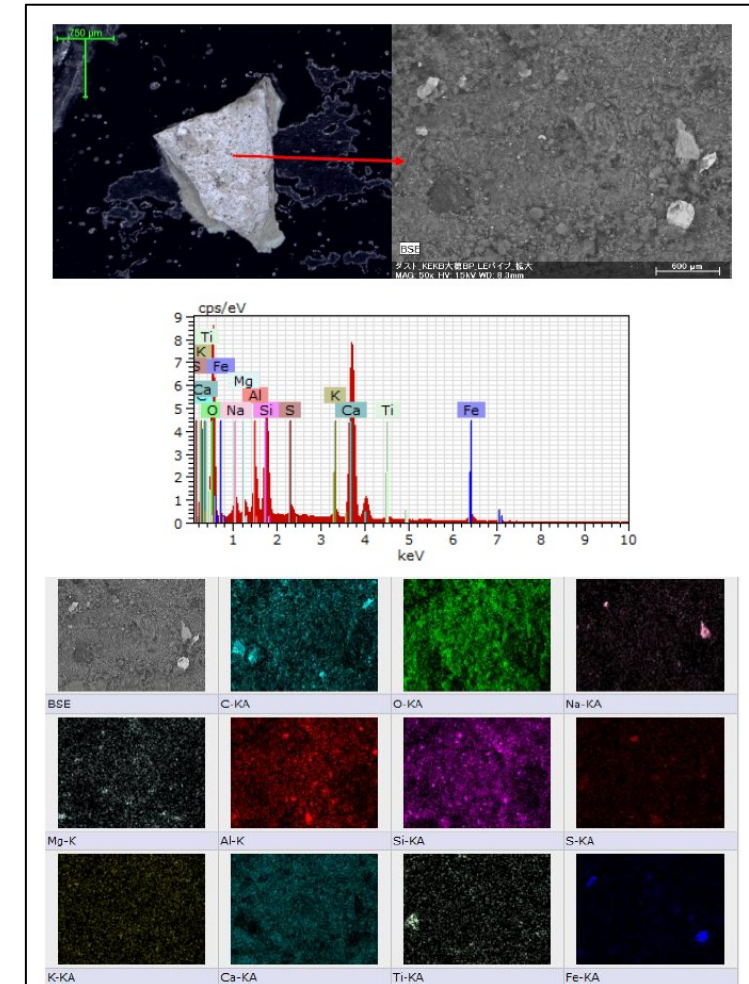
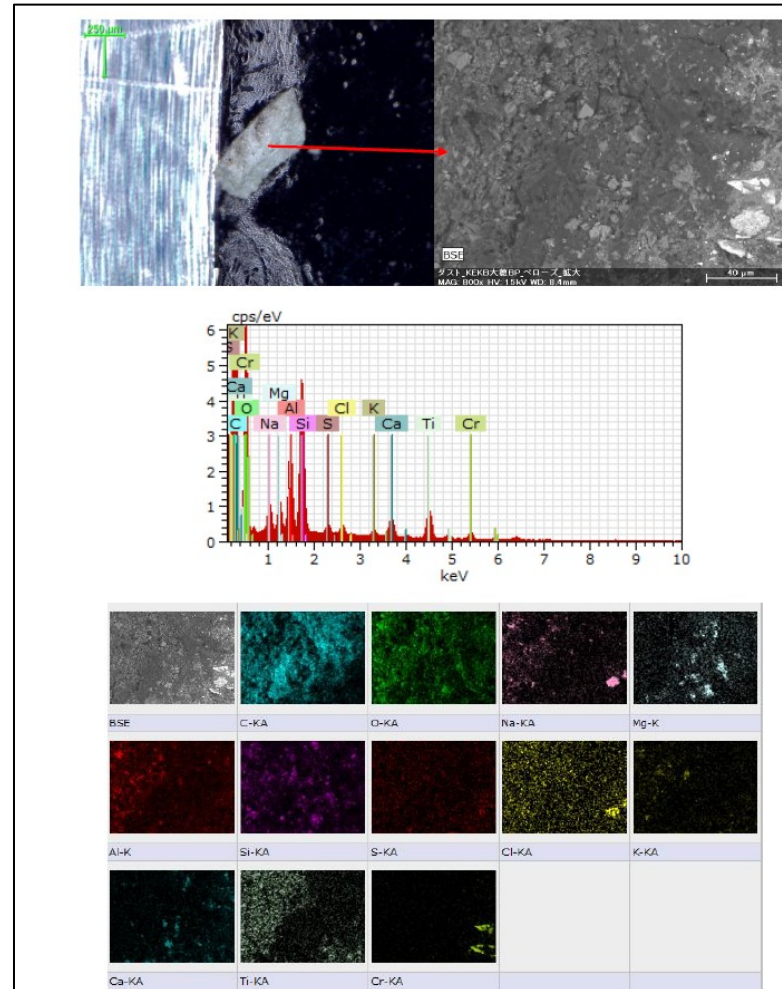

# SEM/EDS analysis of dust particles 3

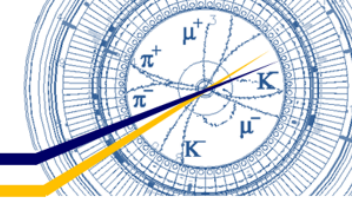

- Dust particles collected from beam pipes installed in D10 wiggler section
  - Middle size particles
  - Main components : O, Al, Si, Ca
  - Others : Mg, Ti, Fe, etc.

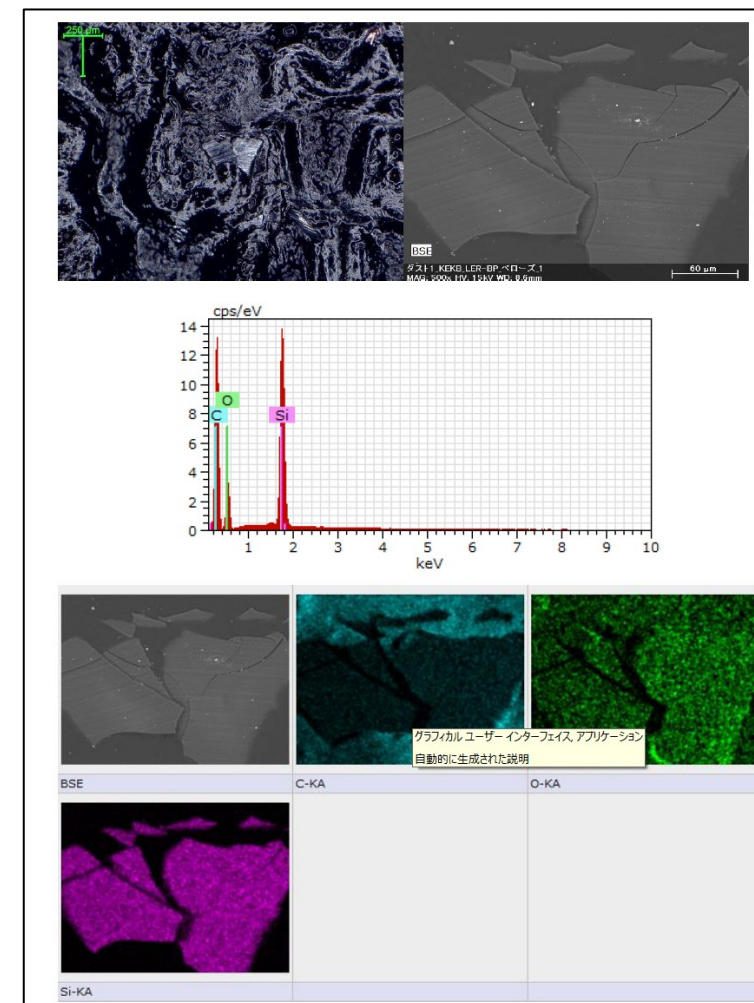
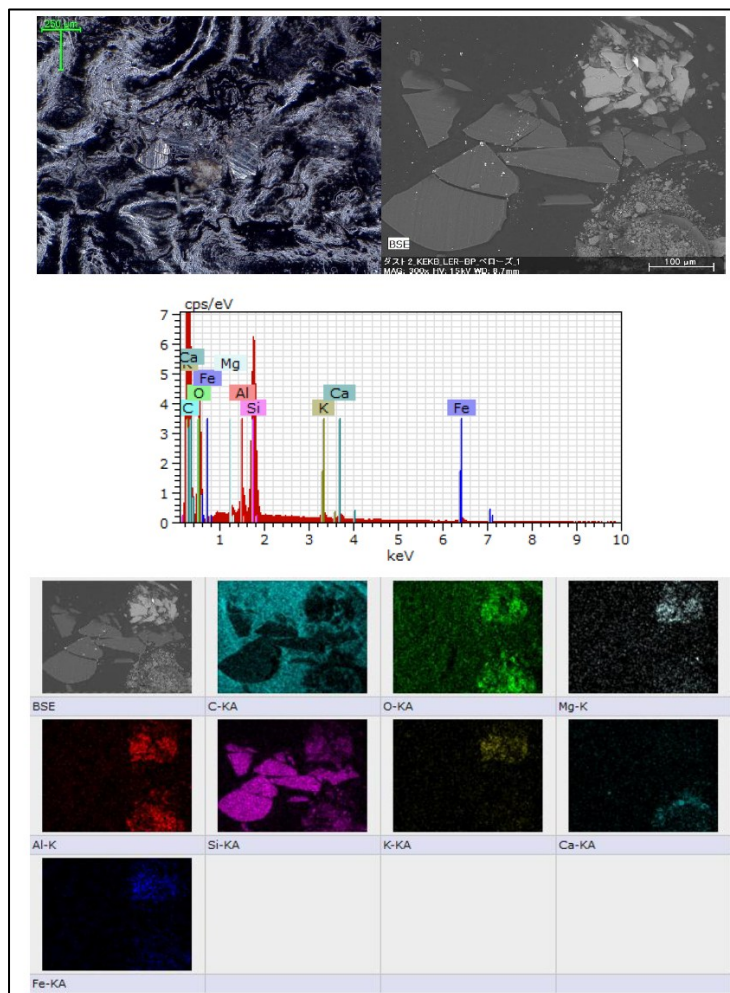



# SEM/EDS analysis of dust particles 4

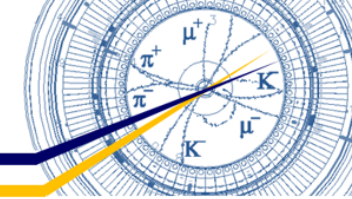

- Reference : Dust particles collected from electrode sample by ultrasonic cleaning
  - Main components : C, O, F, Al, W, Cu

