



# Injector LINAC Status

**Kazuro Furukawa for Injector LINAC**  
<<http://www-linac.kek.jp/linac-paper/general/>>

**Information from all injector group members**

# Improved Precision/Flexibility Injections

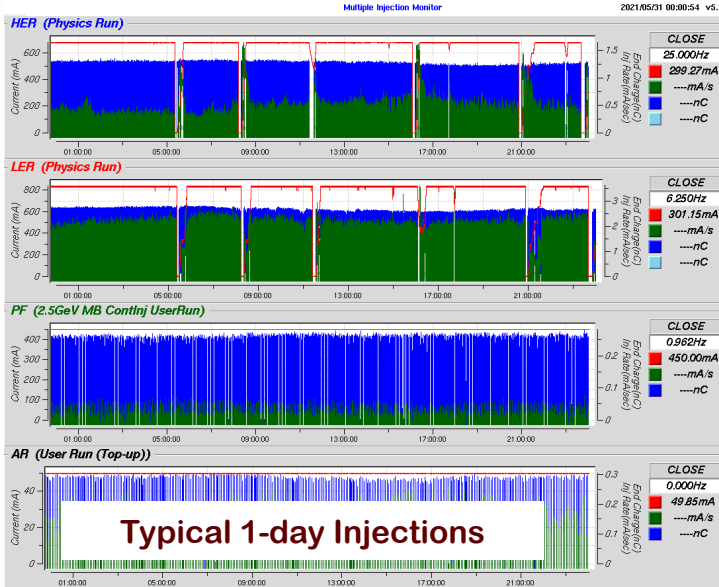

**HER: 800mA, 12.5 – 25 Hz, 1.4 nC, 1 bunch**  
**LER: 1000mA, 12.5 – 25 Hz, 3.0 nC, 1-2 bunch**  
**PF ring: 450mA, <1 Hz, 0.25 nC**  
**PF-AR: 50mA, <1 Hz, 0.3 nC**

- ❖ **red:** Ring current (mA)
- ❖ **blue:** Bunch charge (nC)
- ❖ **green:** Injection rate (mA/s)



Injector operation hours and failure rates

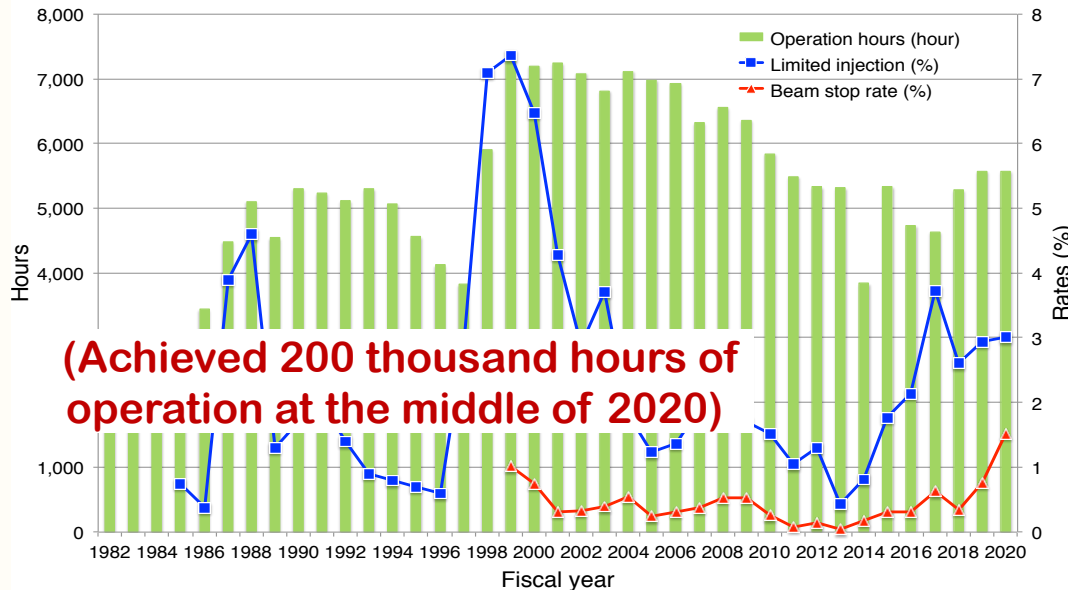

## Event-based Control System

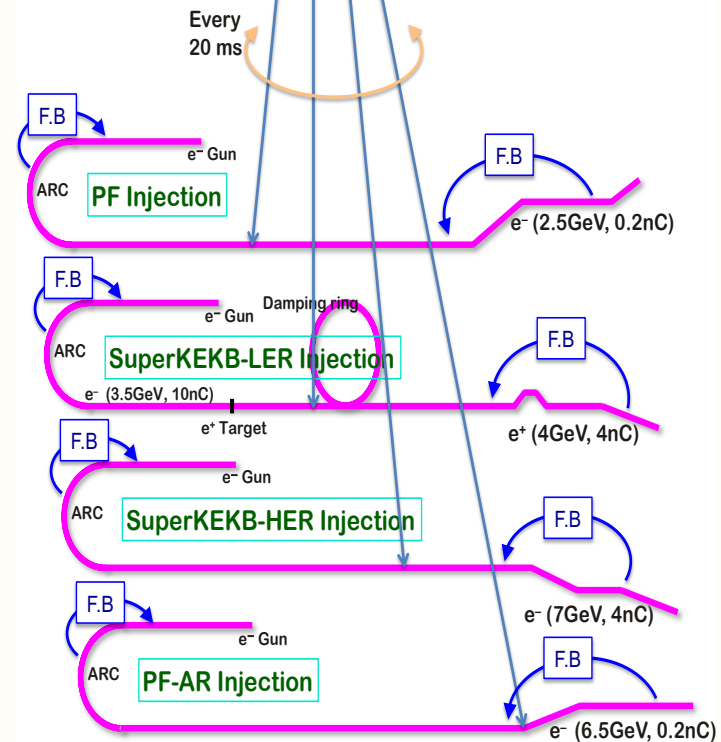

**Four virtual injectors have enabled high efficiency simultaneous top-up injections**

◆ **The injector provide high availability with advanced high-current and low-emittance injections for SuperKEKB as well as light source rings**

# Recent LINAC Development and Progress

## Positron production yield reaching designed value

- ◆ Copper-Nickel alloy was applied to flux-concentrator and resolved the discharge issues
- ◆ Optimized with newly installed correctors and monitors
- ◆ 3 nC/bunch enough for present SuperKEKB operation

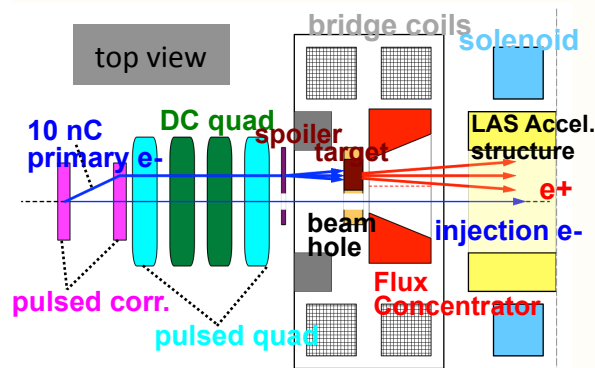
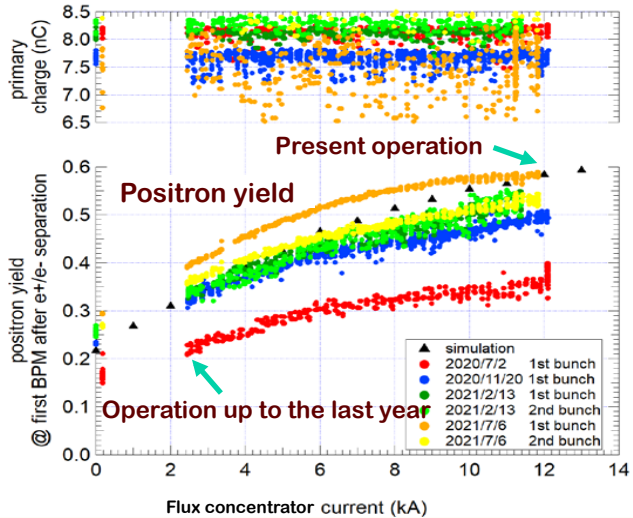

Y. Enomoto

## New accelerating structures were designed and are being fabricated

- ◆ Planning to replace damaged 40 year-old 7% in 230 accelerating structures
- ◆ Succeeded to achieve high acceleration field and low discharge rate with the first 4 structures
- ◆ Will install 12 more structures in 2023
- ◆ Can reach  $\Upsilon$  (6S)

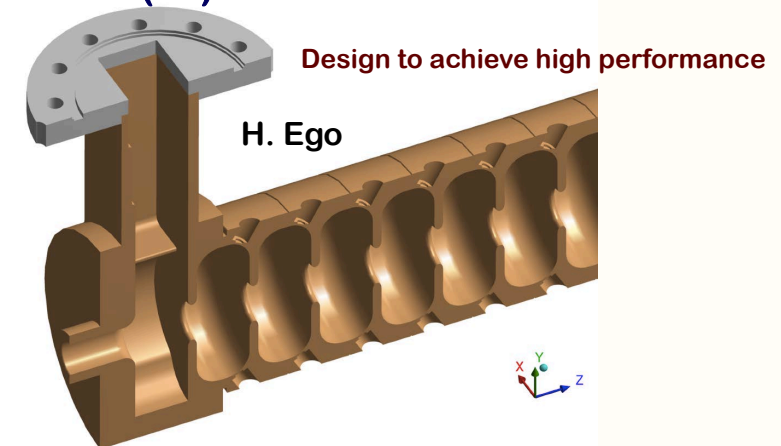

## Steady progress of positron beam

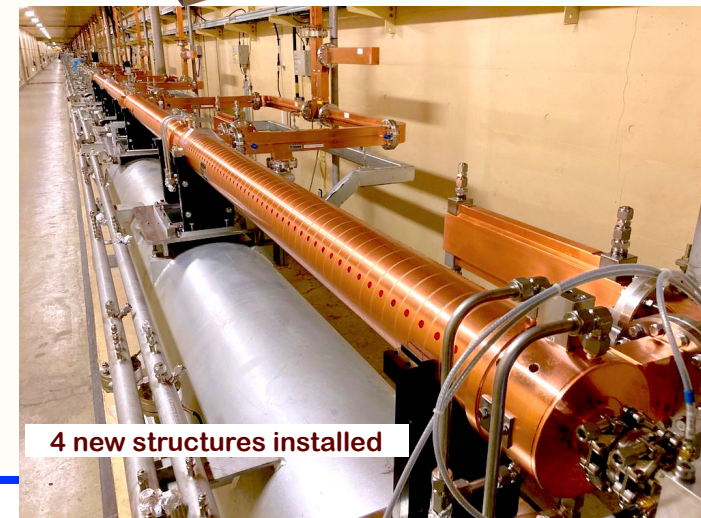
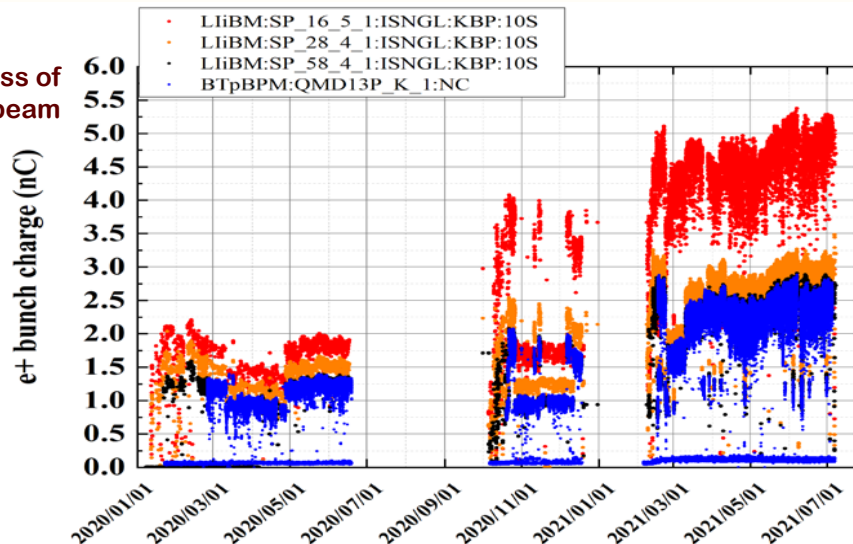

# Electron Beam from RF gun

## ◆ Beam emittance

❖ Present requirement  $\gamma\epsilon_x$  100  $\mu\text{m}$ ,  $\gamma\epsilon_y$  40  $\mu\text{m}$

❖ Stability improvements

- ❏ DOE for 2nd laser
- ❏ Stabilization closed loops
- ❏ 7 additional pulsed correctors

❖ Emittance blow-up in later part of BT

- ❏ Needs further studies
- ❏ CSR is suspected
  - ◆ Vertical blow-up ?
  - ◆ Blow-up behavior with modified optics condition ?
- ❏ Orbit stability
  - ◆ To avoid sextupole field fluctuation from bends
  - ◆ Mitigation by permanent magnet sextupole correctors

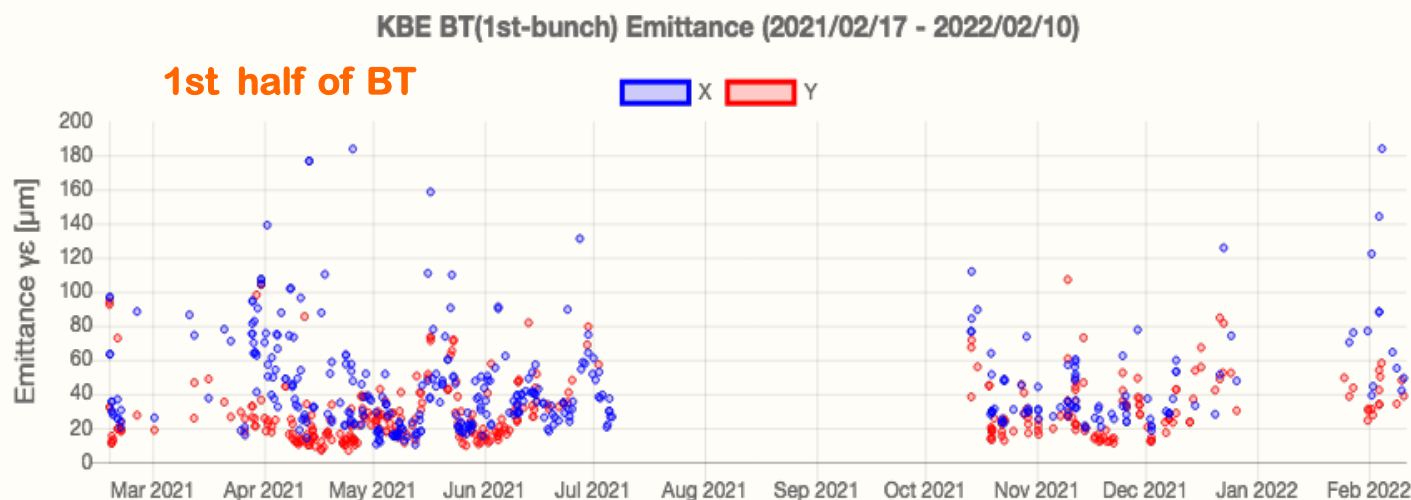
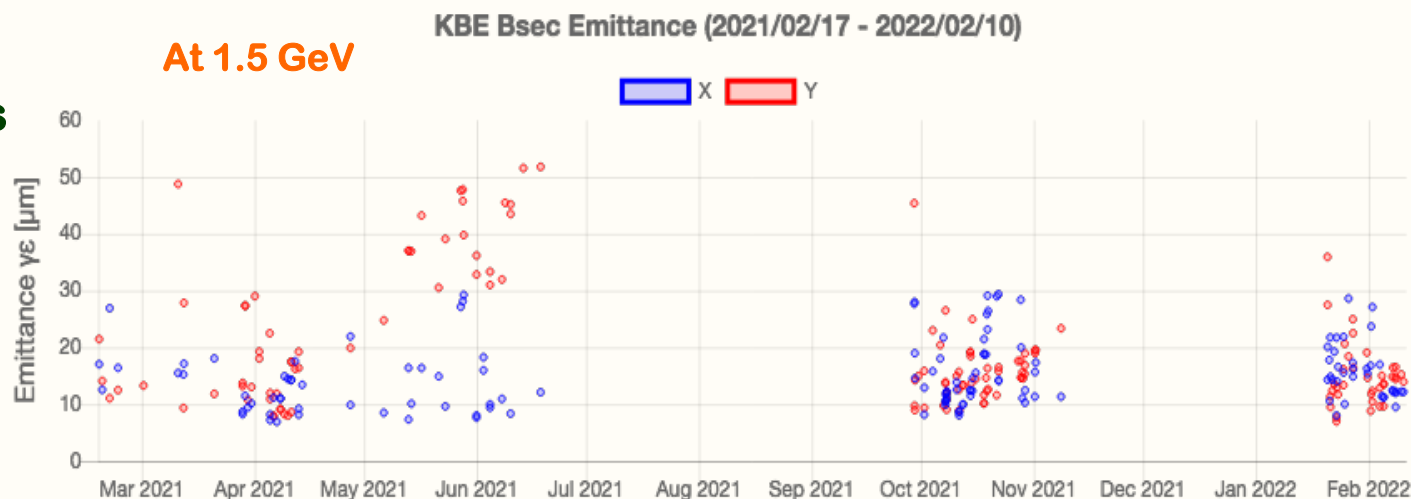





# Injection-1. Improvement of HER injection

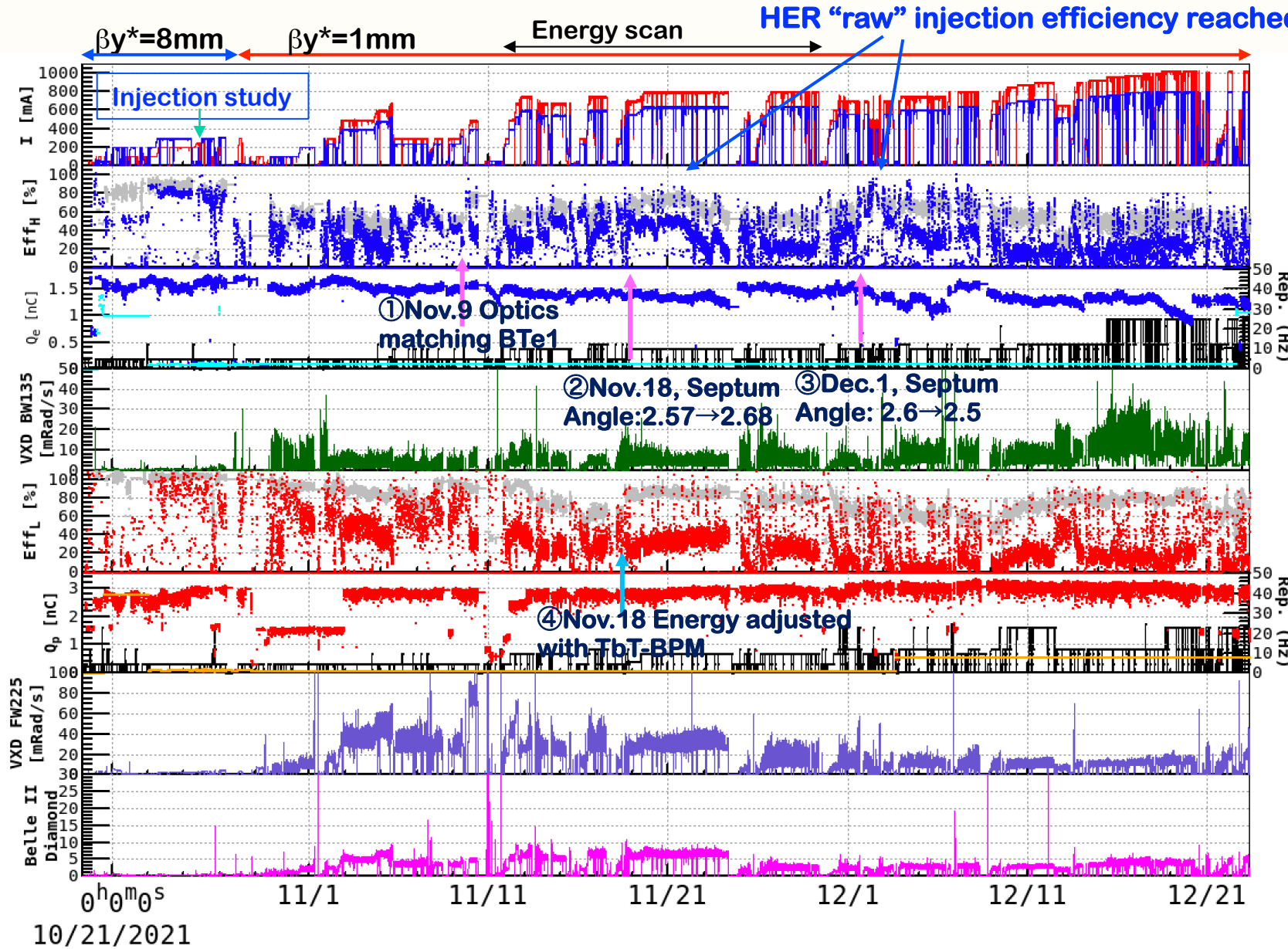

N. Iida

1. HER injection for  $\beta_y^*=1\text{mm}$  has improved, achieved from 60% to 80%.



# Injection-2. Understanding the injection orbit

M. Kikuchi, Feb.4

Injection orbit of the electron beam (unit in mm and mrad)

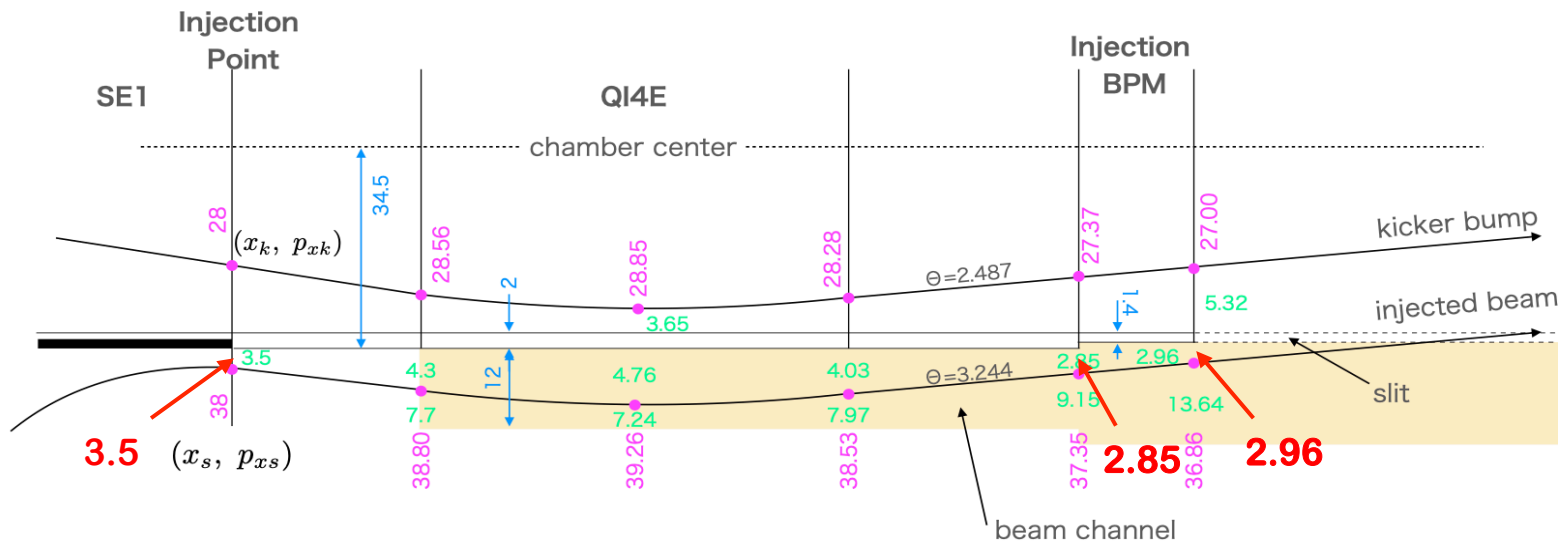

Kicker height and septum position

$$(x_k, p_{xk}) = (28, -1.814)$$

$$(x_s, p_{xs}) = (38, -2.607)$$

$$\sigma_{xR} = 0.7$$

$$\sigma_{xI} = 0.48$$

$$(\epsilon_{xI} = 100 \mu\text{m}, \beta_{xI} = 32 \text{ m})$$

xx.xx Orbit from the chamber center

yy.yy Chamber dimensions

zz.zz Orbit clearance from chamber wall

- ❖ The horizontal orbit of the injection beam for HER has little room to the wall of the injection point chamber.
- ❖ Fairly high residual radioactivity here is observed.
- ❖ It is planned that this chamber will be replaced with a wider one during LS1.



# Injection-3. "Injection-BPM" became a good reference

The horizontal position at "Injection-BPM", so-called "Mitsuka-monitor", has a correlation with the "raw" injection efficiency.

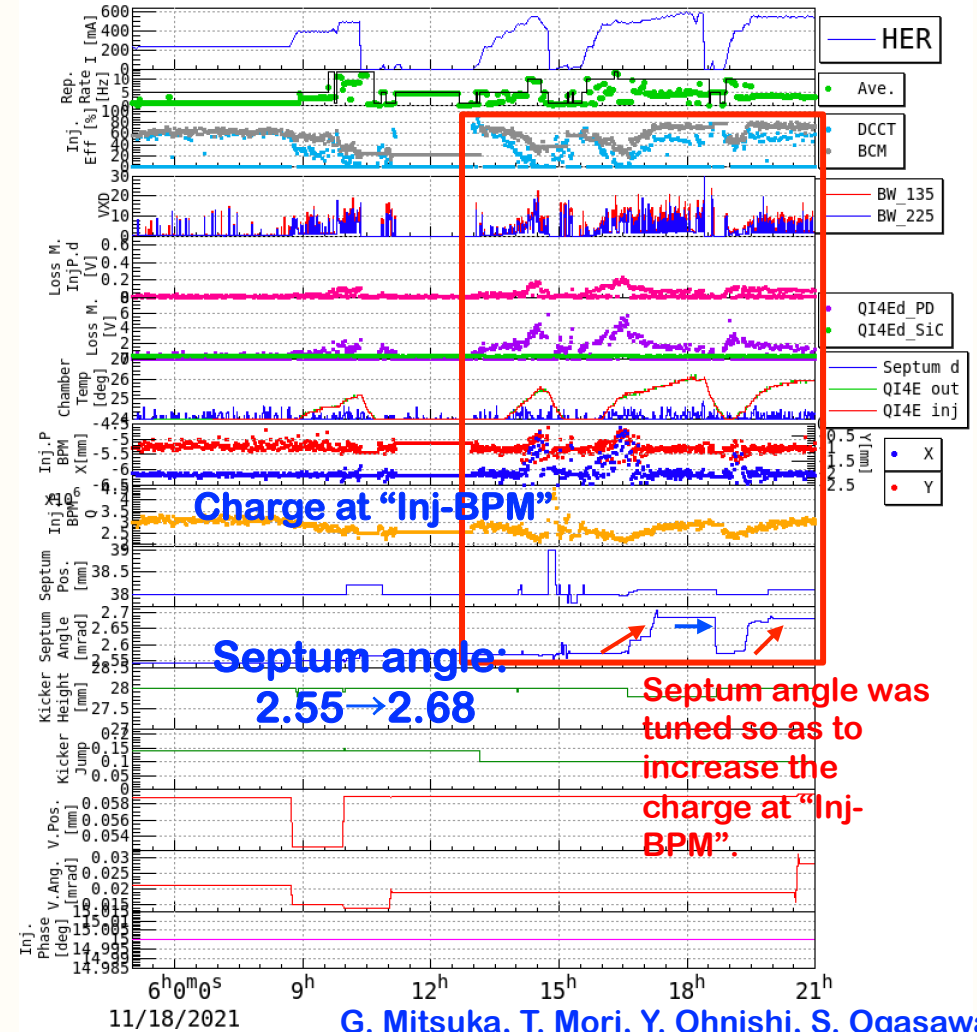
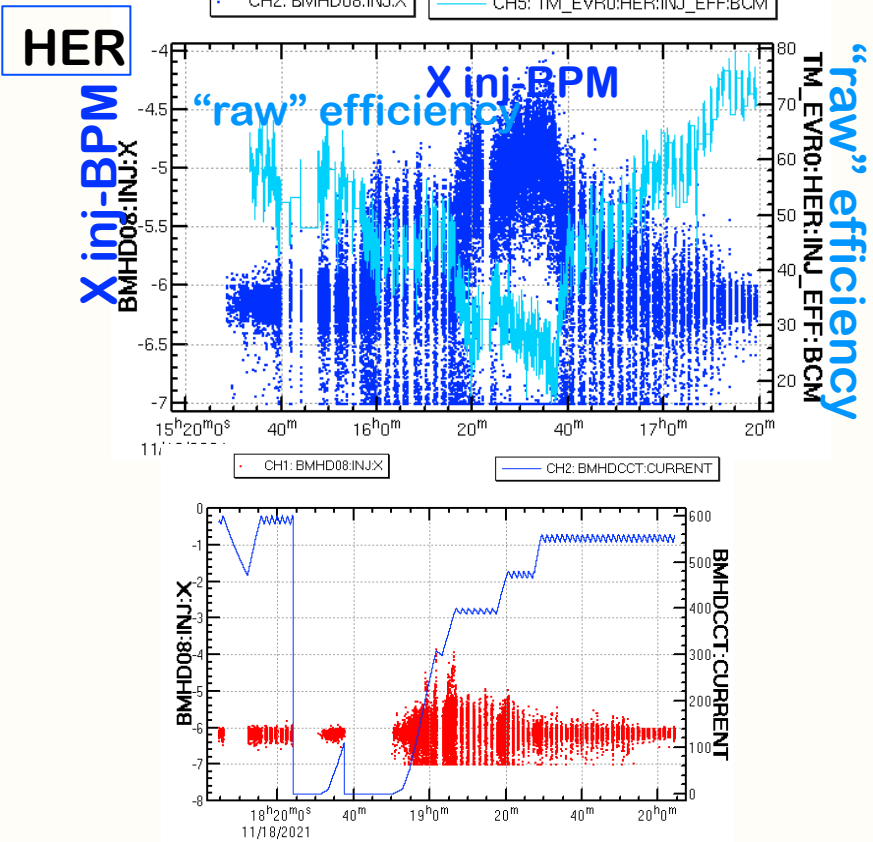

- ❖ The injection tuning panel for the septum magnets has been redesigned considering the design orbit that reduced beam losses at the injection point.
- ❖ The signal of the special beam position monitor ("Injection-BPM") for the injected beam became clear, which helped the injection tuning so much.



# Injection-4. Emittance blowup in the BT lines

N. Iida

Horizontal

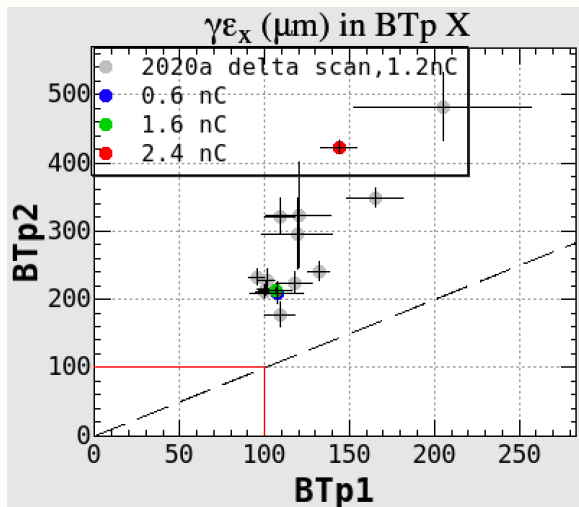

Positron

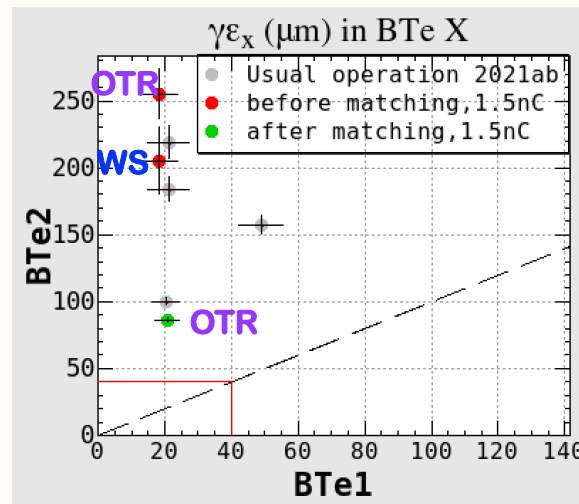

Electron

Vertical

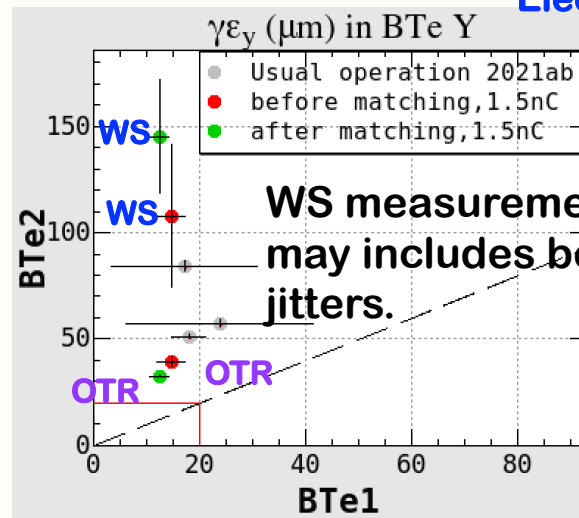
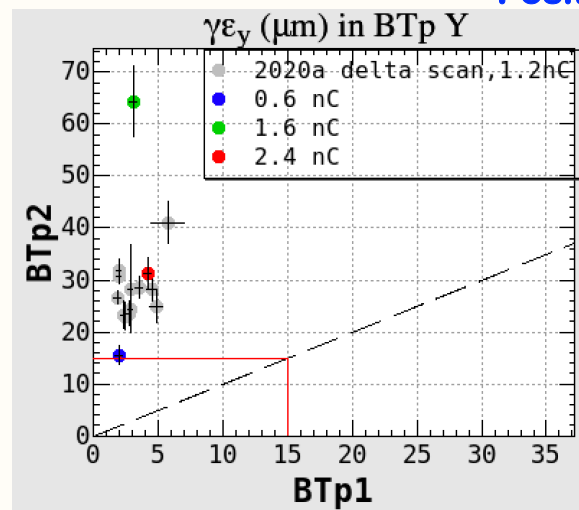

## 4. The emittance blowups between BT1 and BT2 are still unresolved.

- ❖ The horizontal emittance blowup is now observed not only in e<sup>-</sup> BT but also in e<sup>+</sup> BT by increasing beam charge.
- ❖ A coherent synchrotron radiation (CSR) is now the most suspected.
- ❖ We are investigating whether the emittance blowup has charge dependence.



# Injector Linac Improvements

## ◆ Short term : Summer 2021

- ❖ Optical element and amplifier for 2nd Laser of Rf-gun
- ❖ Photo cathode and laser window replacement
- ❖ Core/Edge network switch upgrade
- ❖ 7 pulsed corrector magnet addition
- ❖ Solid-state amplifiers replacing mid-power klystron
- ❖ Damaged waveguide renewal
- ❖ Beam position monitor just after positron target
- ❖ Improved secondary RF-gun as backup
- ❖ Improved protection against AC 50Hz fluctuation

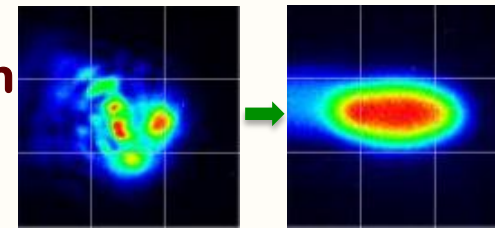

Laser stabilization with DOE element

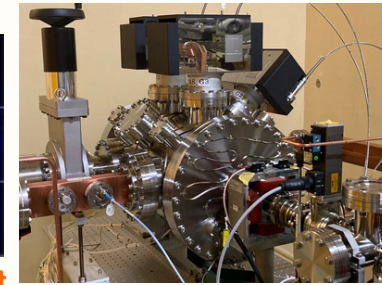

Secondary RF-gun

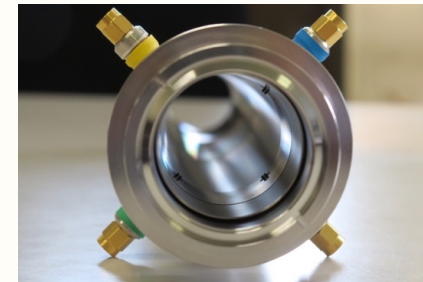

New beam position monitor



Core network switches

## ◆ Mid-term : up to 2026

- ❖ Pulsed magnets & kicker
- ❖ Precision girder mover
- ❖ Energy compression system
- ❖ Improved RF-gun
- ❖ Improved positron generation
- ❖ Accelerating structure upgrade
- ❖ PCB capacitor renewal



Pulsed magnets



High-precision mover

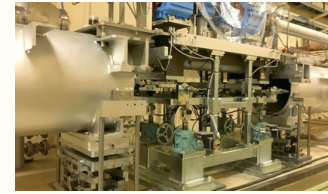

PCB capacitor renewal



Energy compression

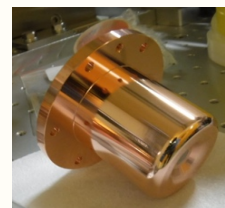

RF gun

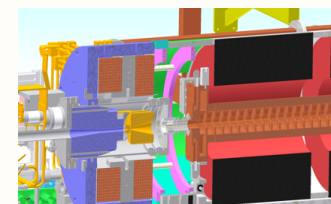

Positron generation

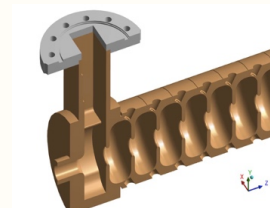

Accelerating structure

# Injector Linac Upgrade Items 2022 - 2026

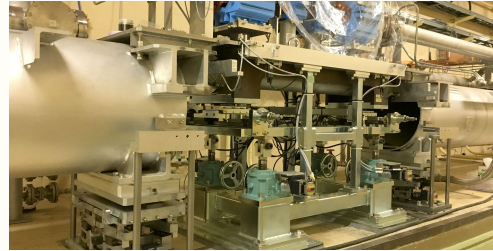
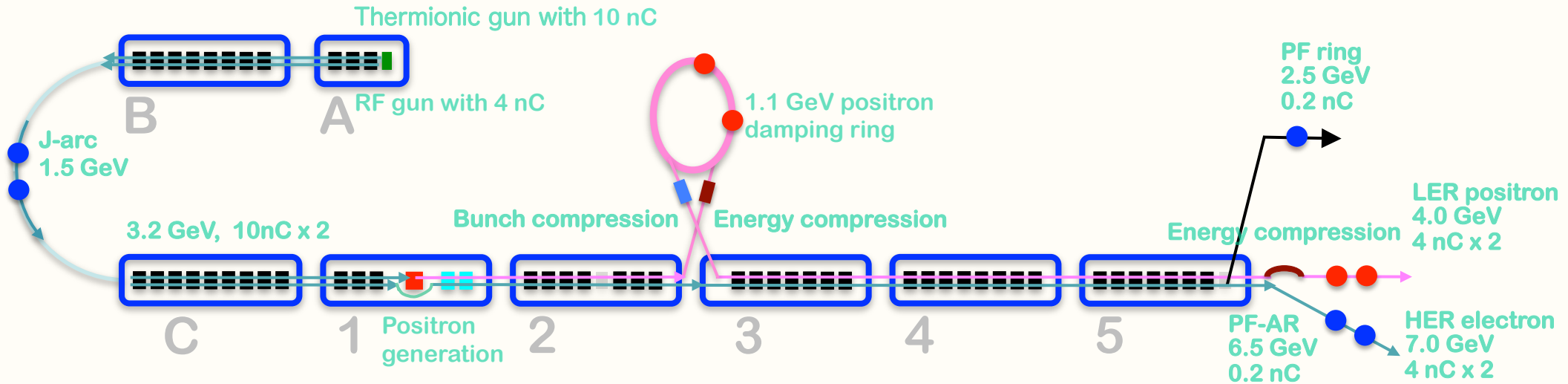

**Pulsed magnets/kickers High precision movers PCB capacitor renewal New energy compressor**

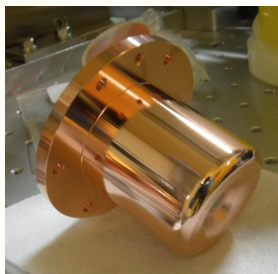

**RF gun**

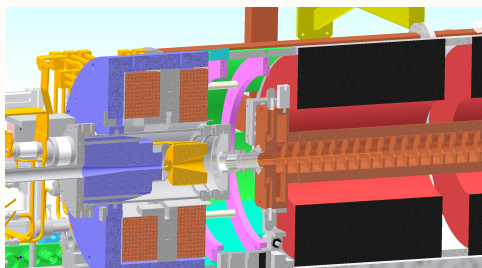

**Positron capture section**

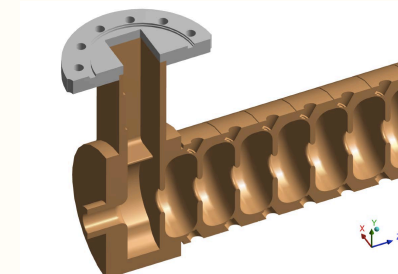

**Accelerating structure**



# Pulsed Magnet, Kicker and Mover

Injector linac injects beams into SuperKEKB HER, LER as well as light sources PF, PF-AR with adequate beam properties at 50 Hz maximum in simultaneous top-up injection scheme. Pulsed magnets, kicker magnets and girder movers will be installed in order to suppress emittance blow-up caused by wakefield in accelerator structure with 4 nC per bunch. Kicker magnets may correct beam orbits separated by only 96 ns. Girder movers may compensate 2-mm annual floor drift at less than 10 microns.

Ceramics chamber integrated kicker development

C. Mitsuda

Pulsed magnets and power supplies

Y. Enomoto, T. Natsui

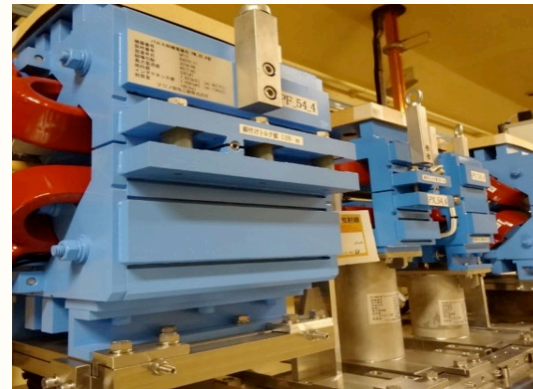

High-precision girder movers

Y. Enomoto



# Higher Energy Injection and Collision

- ◆ **Mitigation of accelerator structure issues**
  - ❖ Originally designed for 8 MeV/m, but has been used at 20 MeV/m
  - ❖ Degradation that lead to high field emission rate and discharges
  - ❖ Water leaks
  - ❖ Not only Y(6S) but even Y(4S) could be endangered
- ◆ **4-year plan to fabricate and install new accelerator structures**

FY 2018	FY 2019	FY 2020	FY 2021	FY 2022
<b>New S-band structure</b>				
<b>Completed !</b> R & D		<b>Completed !</b> High-power test & installation		
	<b>Completed !</b> Fabrication of four structures			
		Material procurement for 12 structures	<b>Completed !</b> Fabrication of 12 structures	
				Conditioning
				Installation
<b>RF source addition</b>				
			Device procurement	Installation
<b>Pulse compressor</b>				
		R & D	Fabrication	Installation
		prototype high-power test		

**Demands for light source operation may delay the installation until summer 2023**



# New Accelerating Structures and ECS for Electron Beam

7% of 230 accelerating structures will be replaced for mitigation of 40-years of degradation by discharges and water leaks.

Energy compression system (ECS) for electron beam will be installed at the beginning of the beam transport line.

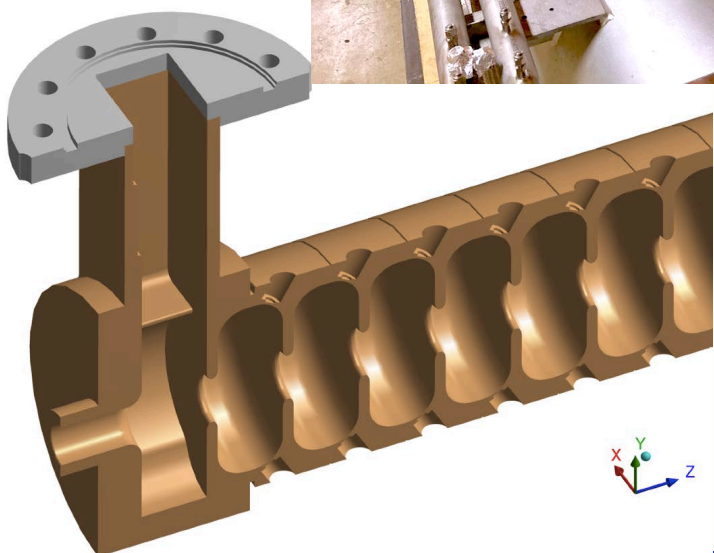
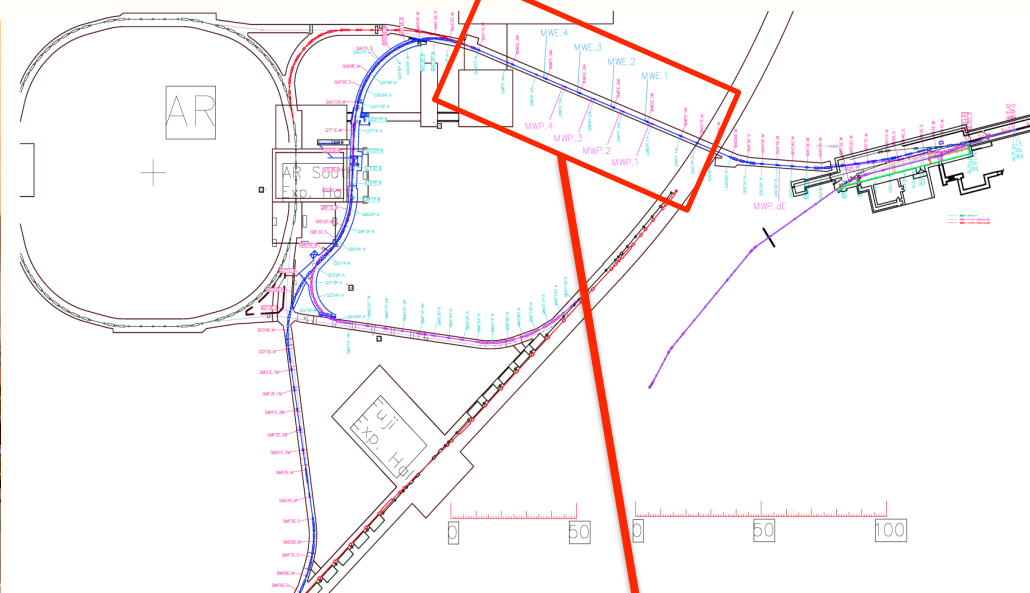
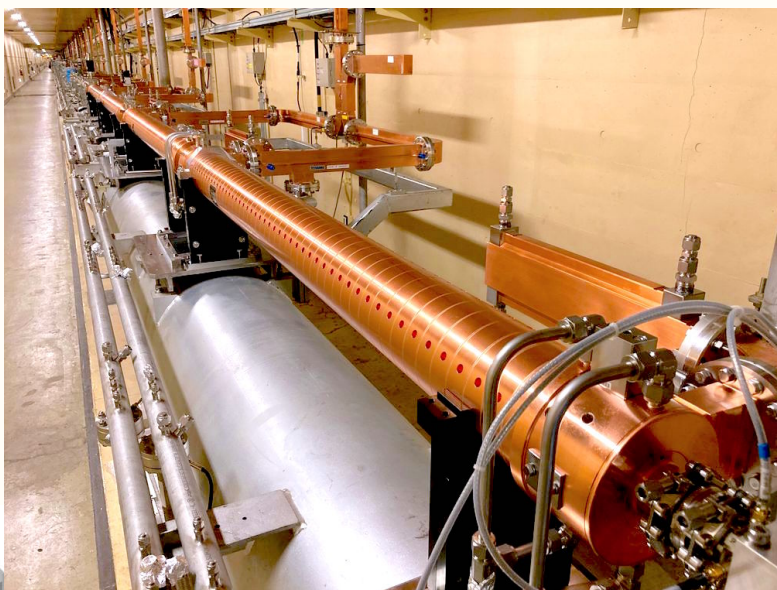

Additional replacement will be necessary in near future.

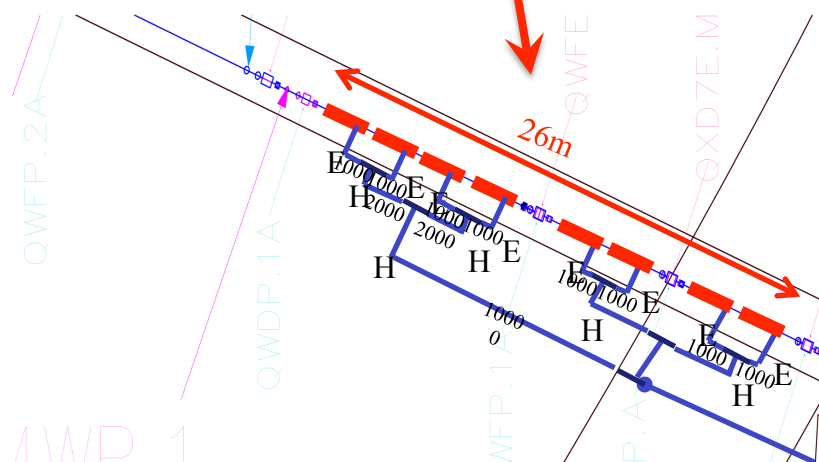

# Capacitors with PCB contamination

Capacitors (up to 1200) in power modulators with low-level PCB produced before 1991 will be replaced following the law.

Capacitors in high-power klystron modulators



Injector linac continues to improve with hardware upgrade in 7 category regions from 2022 to 2026.





# Further Injector Improvement Possibilities

## ◆ After injector upgrade in 7 categories

- ❖ Difficult to foresee now which parameter to improve further

## ◆ Under consideration

### ❖ Further increase in positron bunch charge

- ✧ LER stored current is higher and beam lifetime is shorter
- ✧ Several possible plans exist

### ❖ Beam transport line thru the direct tunnel

- ✧ May relax CSR, etc
- ✧ May interfere with PF-AR operation

### ❖ Even higher energy

- ✧ Not difficult in ring hardware up to 12 GeV with different energy ratio
- ✧ Collision optics design should be investigated
- ✧ Quite expensive modification at LINAC and beam transport line

### ❖ Polarization

- ✧ Physics demand
- ✧ R&D for resources, space, meaningful bunch charge

# Positron Generation Improvements

## ◆ Improvement at summer 2020

- ❖ Cu-Ni alloy for flux concentrator
- ❖ Routine 12 kA operation
- ❖ Correctors inside of 15-m solenoid section
- ❖ Accelerating structure & load
- ❖ Stable 3 nC positron delivery in 2021

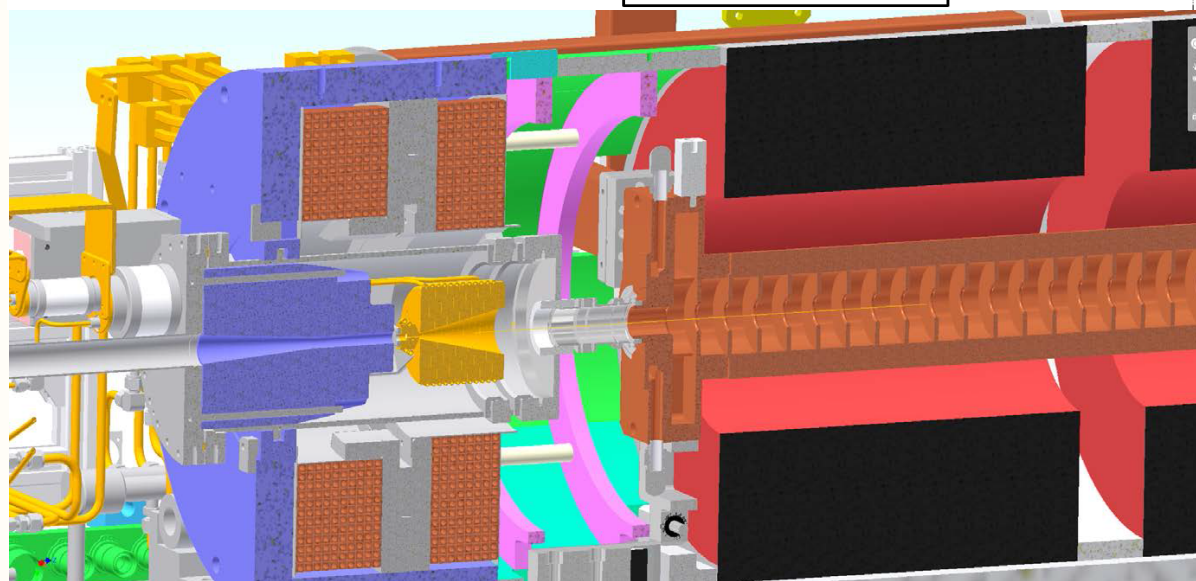
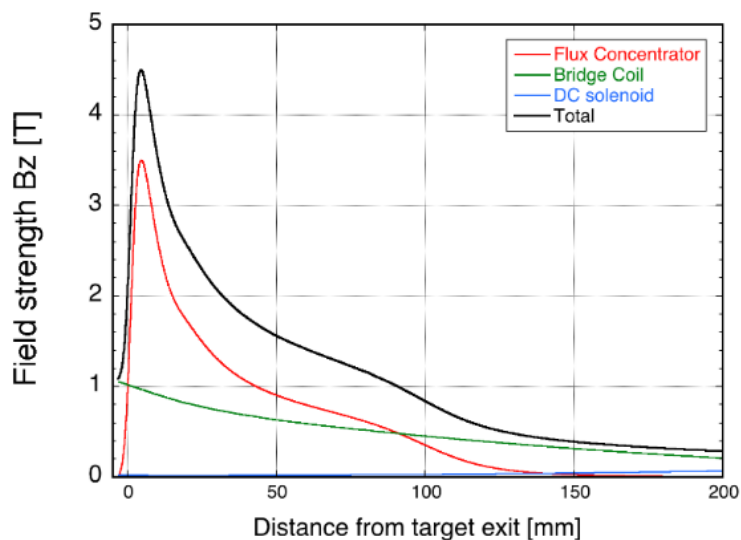
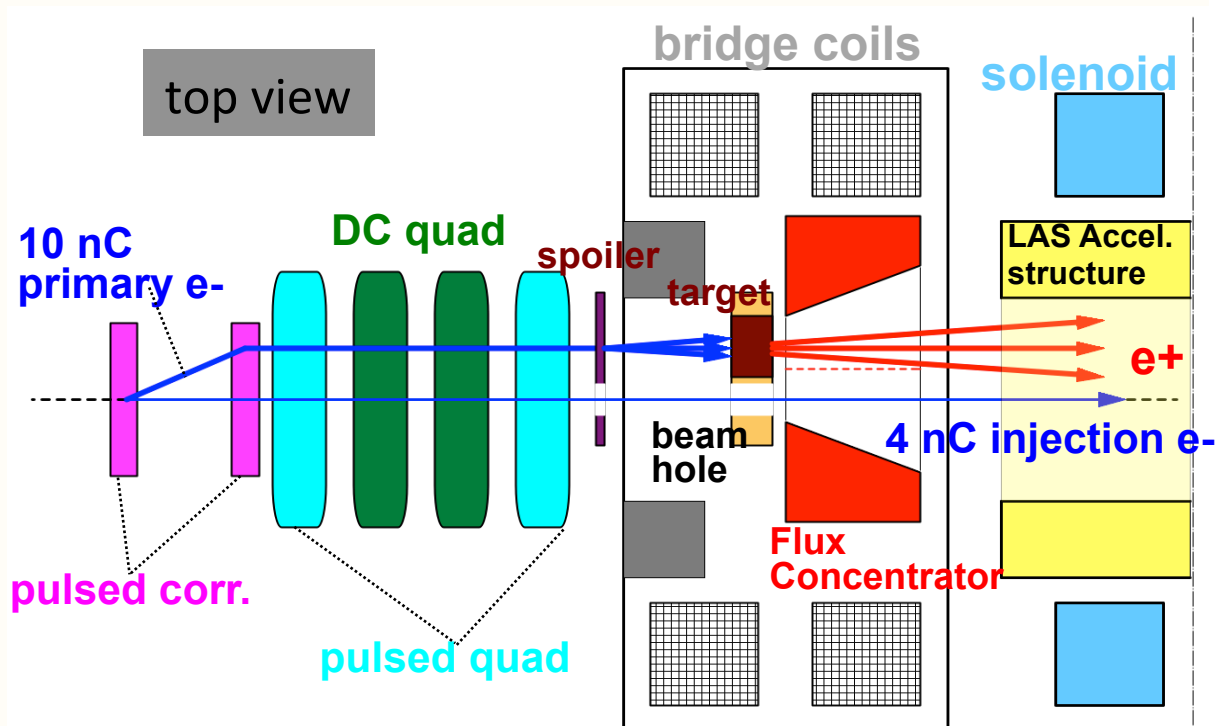



# Further Positron Enhancement

## ◆ Optimization of capturing and bunching

### ❖ Accelerating voltage gradually increasing

- ✧ Long-term RF conditioning
- ✧ Discharge in dummy loads and waveguides being resolved

### ❖ Several beam monitors and correctors were added

- ✧ Spiral beam orbit behavior in solenoid with large energy spread
- ✧ Normal bunching or velocity (decelerating) bunching

New BPM that measures electron and positron separately just after the target before the electron separator. This helps understand positron behavior in solenoidal field.

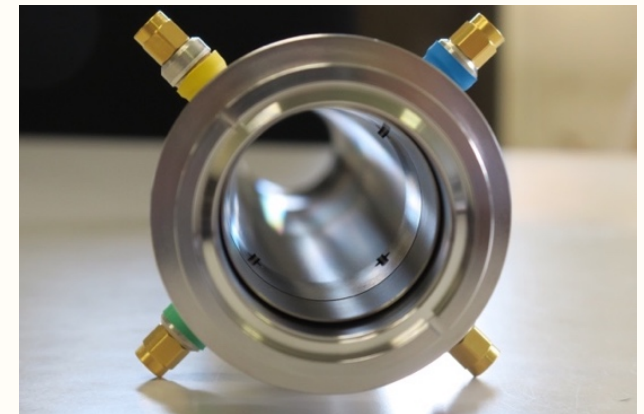
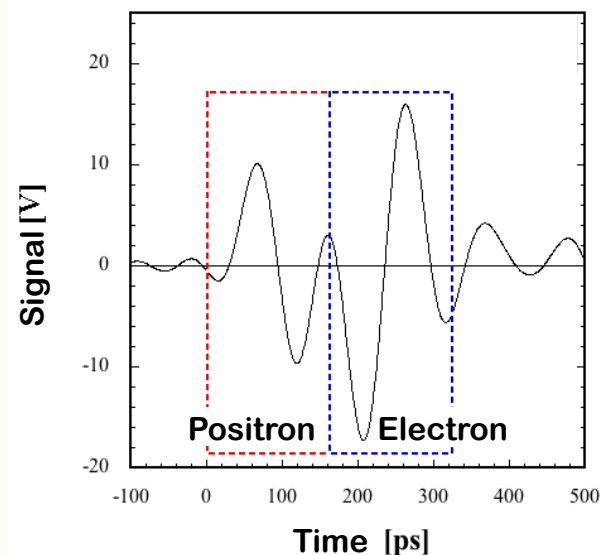

Monitor head

# Further Positron Enhancement (II)

- ◆ **Successful resolution of discharge at flux concentrator**
  - ❖ Introduction of copper-nickel alloy
- ◆ **Successful mitigation of spike waveform**
  - ❖ Simulation of equivalent circuit with detailed stray capacitance

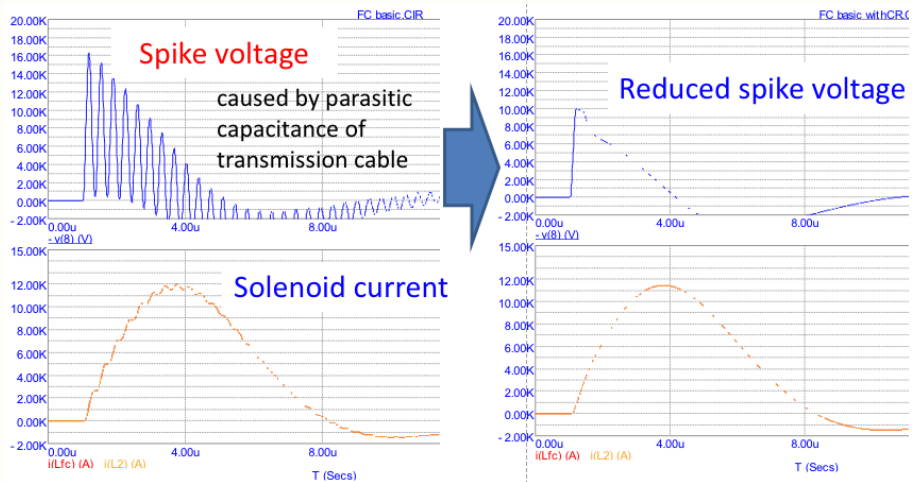

T. Natsui

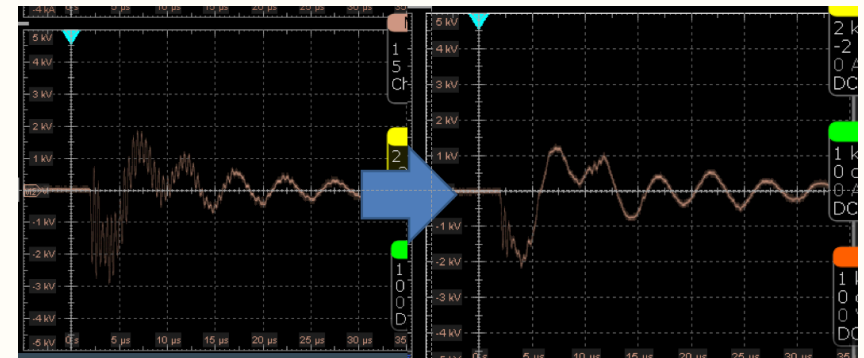

Actual application of the new design

- ◆ **Higher current and higher magnetic field possibility**
  - ❖ With power modulator upgrade

# Further Positron Enhancement (II)

- ◆ **Positron beam not at the center of solenoid / structure**
  - ❖ In order to pass electron beam at the center of structure with lower wakefield
  - ❖ The target is 3.5 mm away from the center of structure and 1.5 mm away from the center of flux concentrator, responsible for spiral beam and lower mag field
- ◆ **Solenoidal field gap between flux concentrator and structure**
  - ❖ For maintainability at high radiation region
  - ❖ After several years of experience, shorter gap possibility

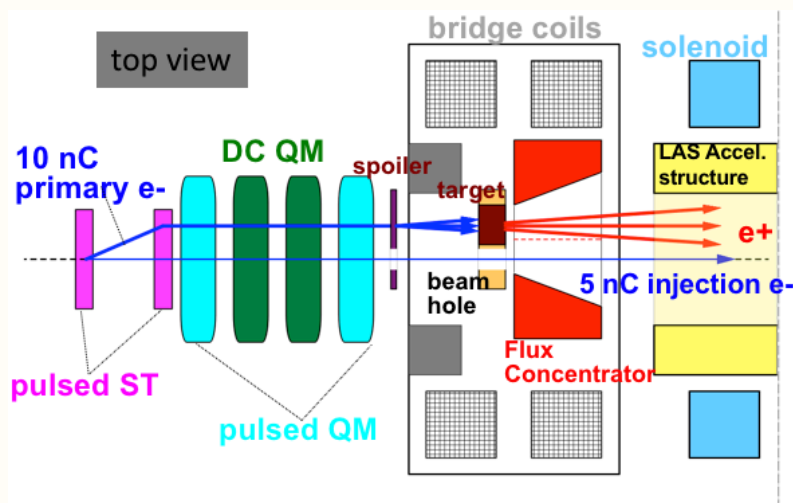

Top view

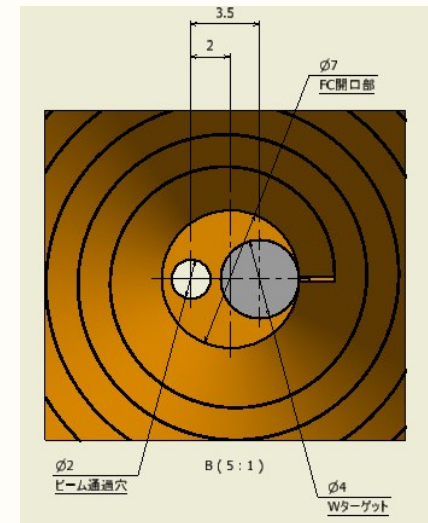

Rear view

- ◆ **Both are the sources of positron loss, and new design is underway**





# Carbon Neutral Activities at Injector LINAC

## High Performance Simultaneous Top-up Injections

700メートルの長さを持つ電子陽電子入射器は、電子ビームや電子の反物質の陽電子ビームを作り出して、高いエネルギーまで加速します。そのビームを素粒子物理実験や放射光科学実験に使用される4つのリング型加速器に向けて送り出します。連続してビームを作ると大きな電力が必要になるので、ビームを100万分の1秒だけパルス加速することによって電力を節約します。さらに入射器は、1秒間に50回もカメレオンのような変わり身をする事ができます。一つの入射器なのに、あたかも4つの入射器が、同時に4つのリング加速器に電子・陽電子ビームを送り出すように振る舞うことができます。

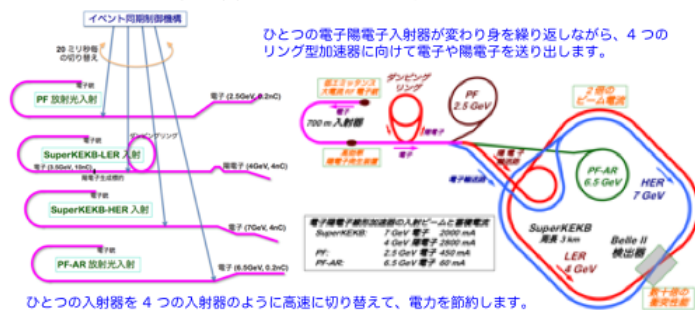
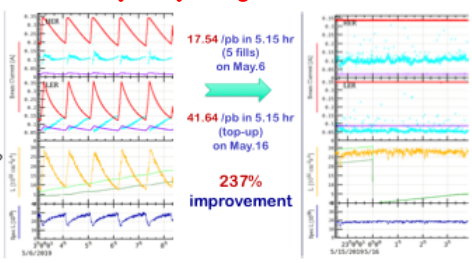

入射器は4千キロワット以上の電力を必要としますので、この変わり身によって、3台分1万キロワット以上の電力を節約していることになります。高速の変わり身を始めた前後でSuperKEKB素粒子衝突実験の成果を比較してみると、上の図のように2.37倍も実験効率が向上したことがわかります。衝突リングの電力は4万キロワットにもなりますから、ここでも電力の節約ができたことになります。

## 69% Power Recovery from Pulsed Magnet Coils

電子陽電子入射器は、エネルギー特性の異なる電子ビームや陽電子ビームを作り出して、素粒子物理実験や放射光科学実験に使われる4つのリング型加速器に向けて入射します。実験成果を最大にするために、入射器は1秒間に50回もカメレオンのような変わり身を行う4リング同時トップアップ入射機構を実現しました。4つのリングへの入射エネルギーが大きく異なるために、それぞれに対応した適切なビーム光学条件を整える必要があります。そこで99台のパルス電磁石を設置して入射毎に磁場強度を変更します。このため専用のパルス電源を開発して、電力の大きい収束電磁石には200V、300Aほどの電力を供給します。この電源は電磁石のコイルとの組み合わせによって電力を回収できるように設計されました。

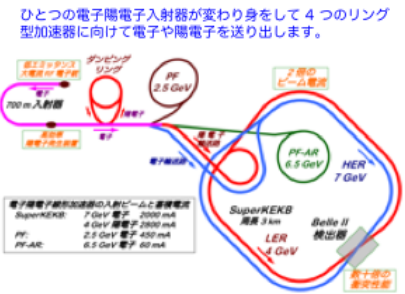

パルス電力が電磁石のコイルに供給されると、電磁石が磁場を発生し適切な特性を持つビームを導きます。コイルが一度パルス電力を受け取ると、今度は逆に電力を返そうとします。以前の電源ではこの戻ってきた電力は熱として捨てられていましたが、この電力を電源のコンデンサで受け取り、20ミリ秒後の次のパルスで再利用することを可能にしました。測定するとその節約割合は69%に達します。1台あたりの電力は約2.5キロワットなので、全体で約100キロワットの電力の節約ができたことになります。

## High Power Conversion Efficiency at Magnet Power Supplies

電子陽電子入射器では、大小さまざまな電磁石電源が390台ほど使われていますが、そのうちの15台ほどにおいては100kW前後の比較的大きな電力が消費されています。さらにそのうちの6台が2000年以前の古い設計の電源であるため、更新することにより効率が改善し、20%から30%の消費電力低減が期待できます。同時に電源の精度・安定度も一桁以上向上させることが可能となり、ビームの安定化に繋がるとともに、不安定であった場合に必要となる安定化機構の計算機等の付加設備が不要となるために、より環境負荷を下げる事が可能になります。さらに電源の力率も大幅に向上するため、伝送路などで無駄に消費される電力も低減させることができます。

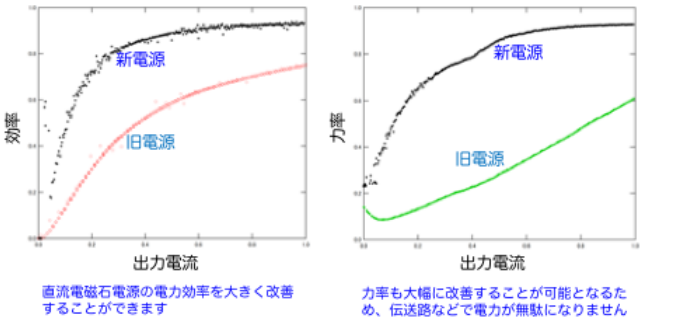

旧型の電磁石電源は年々保守が難しくなっており、安定度も低下しているため、加速器運転に影響する場合も増えており、更新が必要となっています。更新の費用としては、1台あたり1000万円程度となり、6台で6000万円程度を必要とします。しかし、更新により1台あたり20kWから30kWを節約することができますので、電気料金を18円/kWhとすると、保守作業を含めて年間8ヶ月運転で260万円の節約となります。従って約4年で償却できることになります。

## High Efficiency RF Power Distribution

電子陽電子入射器はA~C、1~5の8つのセクタで構成されています。一つのセクタには8台の大電力パルス・クライストロン配置されており、KEKB計画向けに開発された60kWパルス・クライストロン(サブプスタ)からマイクロ波が分配されて駆動されてきました。しかし、製造会社の都合によりサブプスタ・クライストロンの製造が不可能となったため、小型半導体増幅器を用いた分散駆動方式の開発を進めてきました。そして、その安定動作に成功したため、半導体増幅器の導入を進めています。下の図のような構成変更を行うことによって、多様なビーム加速モードに対応する自由度も向上しています。



以前は1セクタ当たりの平均消費電力が2kWでしたが、この構成変更によって電力を60%以上節約して、0.6 - 0.8kWに削減できることがわかりました。残っている4つのセクタを半導体増幅器を用いた分散駆動に変更することにより、さらなる節電を見込むことができます。1セクタの改造に1560万円が費用が必要と見積もられているので、4セクタでは6240万円の費用により約2.8kW分の節約が図られることとなります。(納期については別途調査が必要です。)







# Responses to previous BPAC Comments

- ◆ **Although the current injection rate is adequate, improvements will be needed to achieve higher stored beam currents and shorter ring lifetime.**
  - ❖ **Much improved with a new beam injection monitor. Several possible ideas are being investigated, including physical aperture, optics matching, magnetic field compensation, mitigation of CSR by new beam duct, more synchronized beam instrumentations, etc.**
- ◆ **The positron yield is below the design value. The positron yield needs to be improved in order to keep up with the expected short lifetime of the LER as beam currents increase.**
  - ❖ **Several possible scenarios were presented in this presentation. Presently, it is said to be large enough for the bucket charge quantization.**
- ◆ **The HER injection rate also is low and there is still the emittance increase in the BT to the ring.**
  - ❖ **We are slowly studying the beam behavior between collision operation.**
- ◆ **Further studies on the two-bunch injection for the HER is encouraged, most likely requiring dedicated machine time.**
  - ❖ **Thanks for the recommendation, we will balance it with collision operation and ring study.**
- ◆ **The committee encourages expanding the effort to improve the modelling of the current BT in order to understand where the emittance blowup is occurring; e.g. how much a lattice error needs to be increased in order to induce the observed emittance blowup.**
  - ❖ **We began to understand where the blowup starts, etc. with limited instrumentations.**

# Summary

- ◆ **Injector LINAC continues reasonable injections in simultaneous top-up injection mode.**
- ◆ **Emittance blow-up at the 2nd half of beam transport line is still under investigation, but is partially relaxed recently with finer parameter tuning to make injection and storage beams match.**
- ◆ **The injector upgrade was discussed and will be implemented in 7 categories for the final beam parameters with higher bunch charges and lower transverse and longitudinal emittances. Further upgrade is also investigated.**



# Thank you







# Backup



# DR Optics Change

H. Sugimoto

## (A) Optics using the operation

$\varepsilon_x = 29.9$  nm  
 $\alpha_p = 0.0104$   
 $(\nu_x, \nu_y) = (8.83, 6.28)$

## (B) Low emittance optics (Failed in Apr.2021)

$\varepsilon_x = 17.0$  nm  
 $\alpha_p = 0.0053$   
 $(\nu_x, \nu_y) = (10.21, 6.28)$

## (C) Half-low-emittance optics (Feb.2022)

$\varepsilon_x = 24.8$  nm  
 $\alpha_p = 0.0080$   
 $(\nu_x, \nu_y) = (9.38, 6.28)$

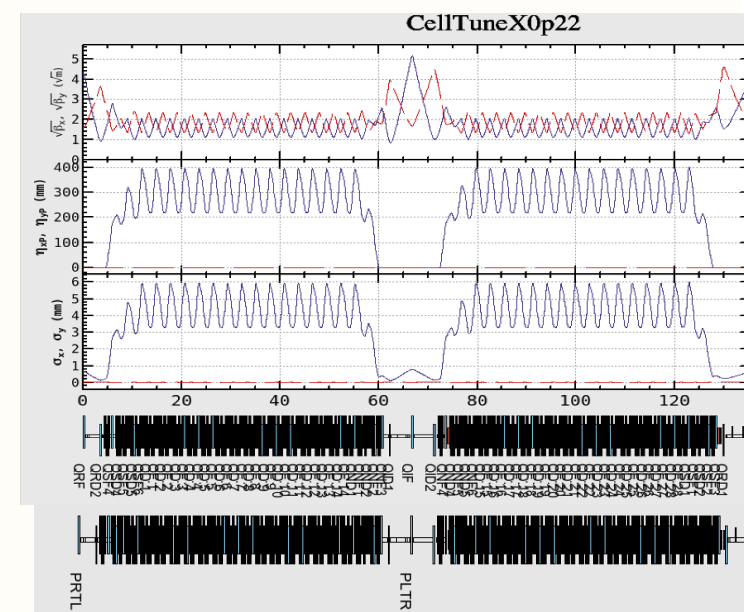
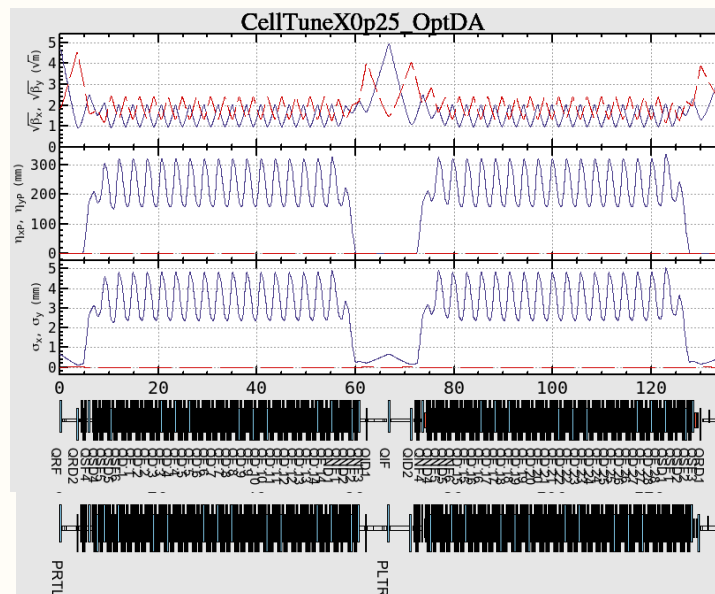
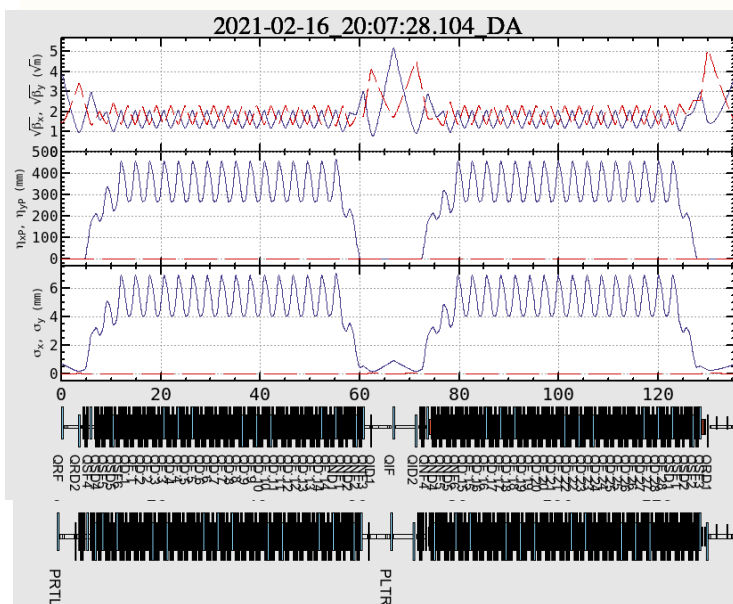





# Linac Beam Parameters for KEKB/SuperKEKB

Stage	KEKB (final)		Phase-I (achieved)		Phase-II (achieved)		Phase-III (interim)		Phase-III (final)	
	e+	e-	e+	e-	e+	e-	e+	e-	e+	e-
Beam Energy	3.5 GeV	8.0 GeV	4.0 GeV	7.0 GeV	4.0 GeV	7.0 GeV	4.0 GeV	7.0 GeV	4.0 GeV	7.0 GeV
Stored current	1.6 A	1.1 A	1.0 A	1.0 A	-	-	1.8 A	1.3 A	3.6 A	2.6 A
Life time (min.)	150	200	100	100	-	-	-	-	6	6
Bunch charge (nC)	primary e- 10		primary e- 8						primary e- 10	
	→ 1	1	→ 0.4	1	0.5	1	2	2	→ 4	4
Norm. Emittance	1400	310	1000	130	200/40	150	150/30	100/40	100/15	40/20
( $\gamma\beta\epsilon$ ) (mrad)					(Hor./Ver.)		(Hor./Ver.)	(Hor./Ver.)	(Hor./Ver.)	(Hor./Ver.)
Energy spread	0.13%	0.13%	0.50%	0.50%	0.16%	0.10%	0.16%	0.10%	<u>0.16%</u>	<u>0.07%</u>
Bunch / Pulse	2	2	2	2	2	2	2	2	2	2
Repetition rate	50 Hz		25 Hz		25 Hz		50 Hz		50 Hz	
Simultaneous top-up injection (PPM)	3 rings (LER, HER, PF)		No top-up		Partially		4+1 rings (LER, HER, DR, PF, PF-AR)		4+1 rings (LER, HER, DR, PF, PF-AR)	

## Gradual improvements keeping light source injections

# Emittance Preservation

- ◆ Offset injection may solve the issue
- ◆ Orbit have to be maintained precisely
- ◆ Mis-alignment should be  $<0.1\text{mm}$  locally,  $<0.3\text{mm}$  globally

Mis-alignment leads to Emittance blow-up

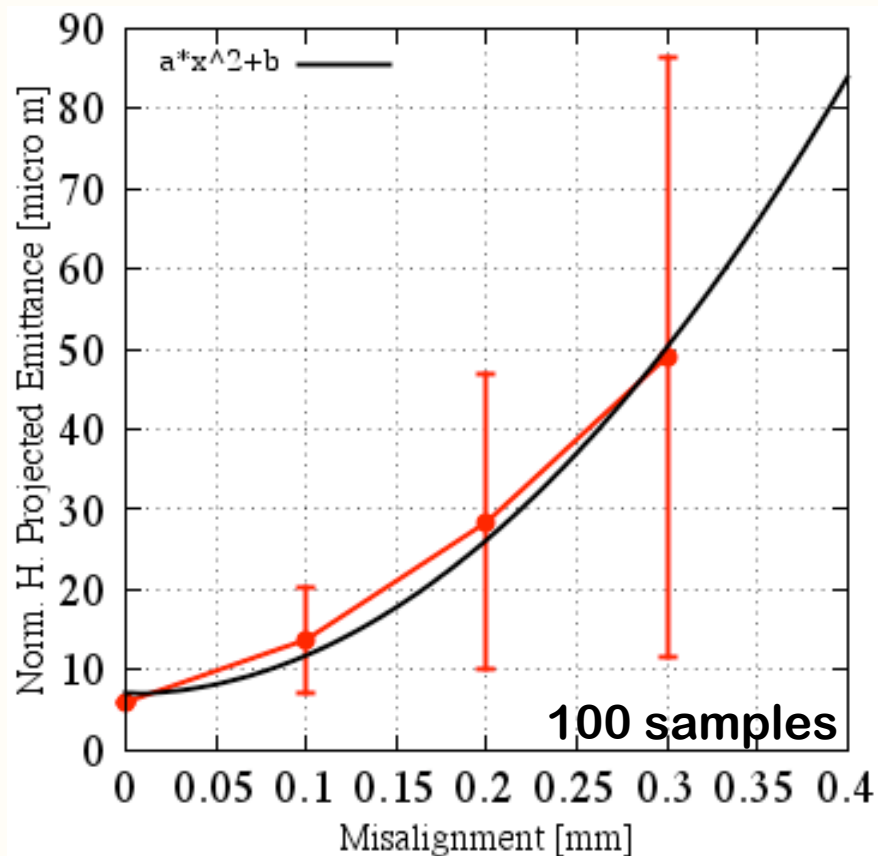

Orbit manipulation compensates it

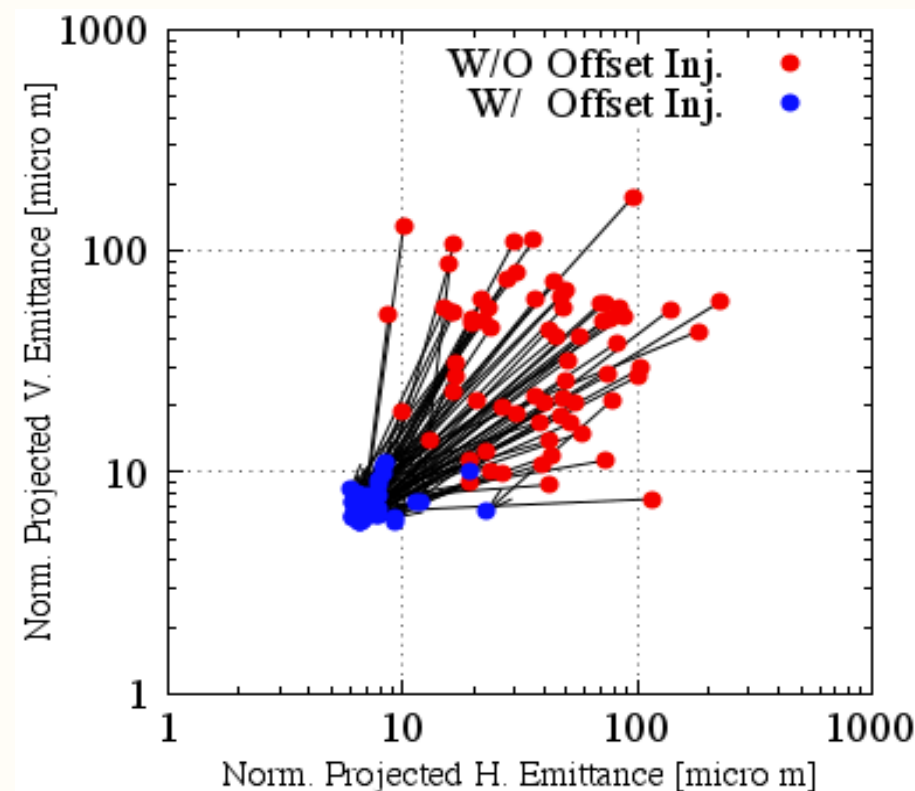

Sugimoto et al.

# Floor vertical movement

## in a half year from summer to winter

Higo et al.

