

# DEVELOPMENT OF FIELD-EMISSION ELECTRON GUN FROM CARBON NANOTUBES

Y. Hozumi<sup>1,A)</sup>, S.Ohsawa<sup>B)</sup>, T. Sugimura<sup>B)</sup>, M. Ikeda<sup>B)</sup>

<sup>A)</sup>The graduate university for advanced studies, <sup>B)</sup>KEK, 1-1 Oho, Tsukuba, JAPAN

## Abstract

Aiming to develop a high intensity electron beam with narrow energy-spread for injector guns, we have been tested field emission cathodes of carbon nanotubes (CNTs), which have some features of easy handling and low cost. Experiments for these three years brought us important suggestions and a few rules of thumb. Now at last, anode current of 3.0 A/cm<sup>2</sup> was achieved with 8 kV acceleration voltage by applying short grid pulses between cathode and grid electrodes<sup>[1]</sup>. In order to proof utility, 100-kV gun system had been designed and constructed since last year. Then the value of 100 mA was obtained based on 10<sup>-5</sup>~10<sup>-6</sup> Pa back ground pressures. With some improvements it would be expected that anode currents of Ampere order will be obtained from the CNTs cathode gun.

## INTRODUCTION

The heater-less electron guns (e-guns) are desired because of its excellent emission properties, i.e., low emittance, high brightness and low cost driving. Field emission (FE) e-guns are under investigation for injector linacs. This time, we have been fabricated and tested a new type of FE-gun using the promising material emitter called “carbon nanotubes (CNTs)”. The CNTs have strong potentials as a field emitter; actually, 1×10<sup>9</sup> A/cm<sup>2</sup> of current density has recently obtained in Japan. In the last year, it was reported that anode current of 3.0 A/cm<sup>2</sup> was achieved from CNT-FE e-gun by applying short grid pulses between cathode and grid electrodes<sup>[1]</sup>. The CNTs cathode which had enough current density and long lifetime could be developed by some companies’ cooperation<sup>[2]</sup>. The report results were obtained with as low acceleration voltage as 8 kV, and this time, we have constructed a 100 kV practical test stand and started test of performance of the e-gun which were also designed to suited EIMAC-Y796 standard. This paper describes the basic design and the characteristics of the CNTs FE-gun.

## COMPOSITIONS OF THE E-GUN SYSTEM

### Measurement System and Electrical Circuits

At the gap distance between the grid and cathode (G-C) electrodes, short pulses of 50 ~ 100 ns width and 0.1 ~ -3.4 kV are applied through a BNC connector with a repetition rate of 7~10 Hz. 50 ns is the lower limit of the pulse generator PVX-4140 produced by DIRECTED ENERGY, INC. Figure 1 shows this system outline. The

50 Ω resistance connected to the pulser in series has a role of mitigating damage of the cathode from discharge, and reflected pulses due to impedance miss match. The emitted electrons are accelerated by DC high voltage of 100 kV between the anode and grid electrodes, and then emerge from the e-gun through an anode hole. Then, electron beams are adjusted by a magnetic lens to focus on the beam catcher (BC) in solenoidal fields. The values of beam currents are measured by monitors such as a wall current monitor (WCM), a core monitor (CM) and BC, which are set along the beam line. Furthermore, a fluorescence screen is available, if necessary, by inserting in the beam line instead of BC at the same place.

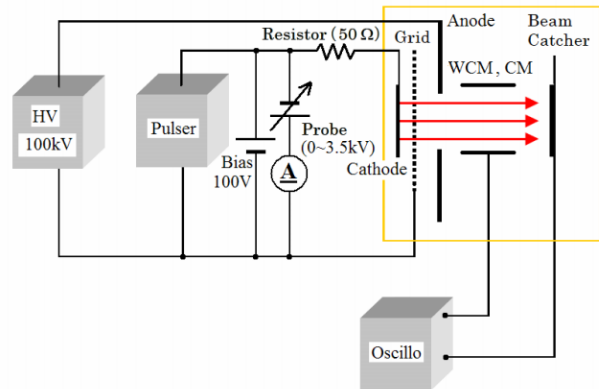

Figure 1: The main components of the e-gun system

### Structures of the E-Gun

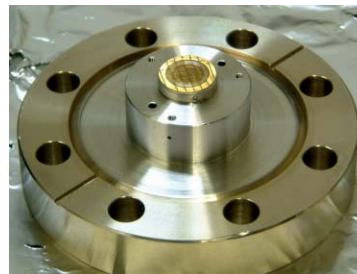

Figure 2: The e-gun view

Figure 2 shows e-gun structure viewed from the grid side. A standard vacuum flange ICF88 is adopted for the e-gun in order that it is compatible with the often used cathode EIMAC-Y796. The distance between the G-C is very important, because it determines the field gradient between the G-C with grid pulses, namely beam currents. Therefore we designed the structure of the G-C assembly

<sup>1)</sup>hozumi@post.kek.jp

so that the distance is given mechanically from the components in an accuracy of 10  $\mu\text{m}$  by means of compressing with a screw from BNC connector side. By changing height of a cathode base the distance will be easily changed. Furthermore it is easy to assemble the G-C mechanically it is suitable to make a test for many pieces of cathodes by changing one to another.

Figure 3 shows the Wehnelt electrode with a grid-cathode assembly at the center. The slope angle of 22.5 degrees was chosen to get a parallel beam following Pierce's theory. In the picture there is space between the Wehnelt electrode and outside of the G-C assembly. Its space is actually filled with a cover of SUS in case of measurements. Figure 4 shows an anode electrode which was made into monotonous structure, and attached the roundness of R2 to the beam hole, which was an entrance of the beam (10 mm diameter), and the anode surfaces were similarly processed like a mirror to Wehnelt electrode to avoid discharge.

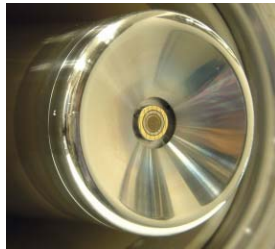

Figure 3: Wehnelt

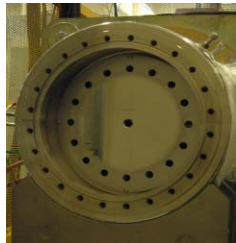

Figure 4: anode

*Beam Trajectory Simulation*

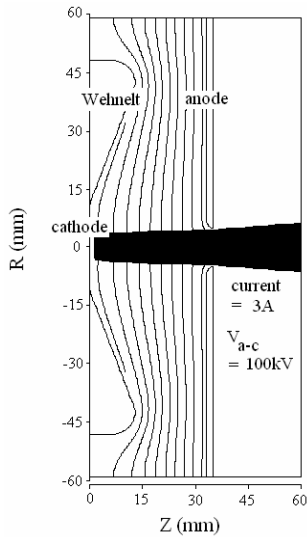

Figure 5: Simulation results image

Trajectories were simulated by the code EGUN with an assumption that electrons were uniformly emitted from the cathode surface at room temperature (defined as 300 K) with a cathode current of 3 A at an acceleration voltage of 100 kV. It was confirmed that beams from a

cathode of which diameter are 6 mm could be extracted satisfactorily through the anode hole.

**BEAM TEST**

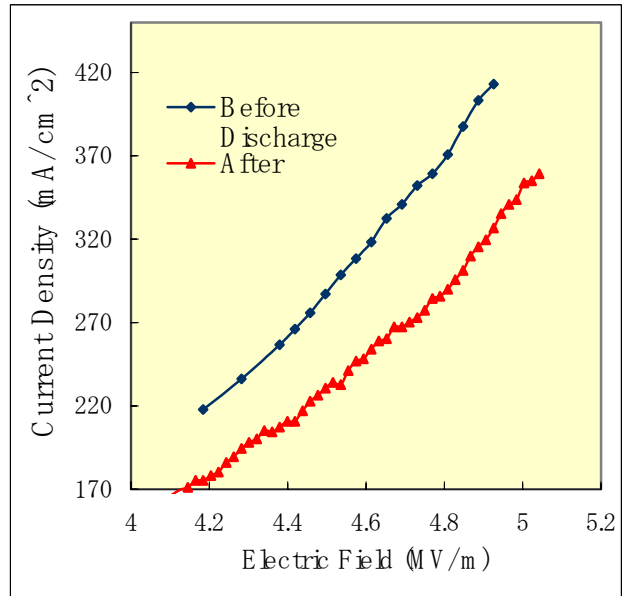

Figure 6: Reduced current density from anode current

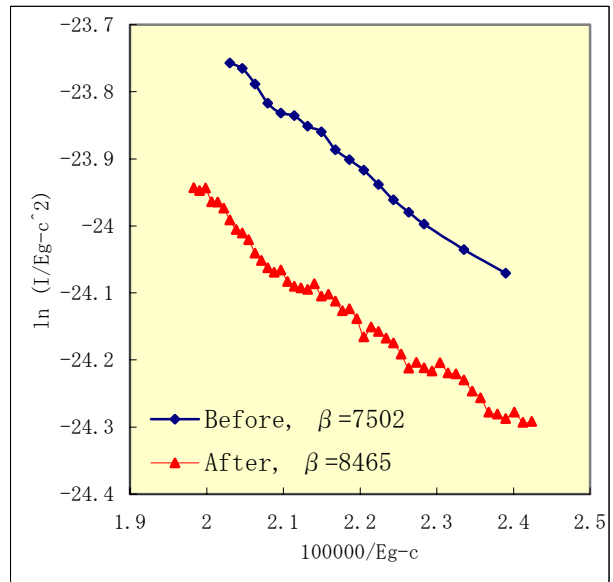

Figure 7: The Fowler-Nordheim plot of Fig.6

The beam tests were performed at the e-gun test stand, where acceleration is capable up to 120 kV. Its construction started from October last year, and completed it in February this year.

In this system, beams from the cathode are mainly controlled by pulses applied between the G-C, namely beam values such as intensity and pulse width controlled by the pulses. On the other hand, beams are accelerated by DC high voltage of 100 kV impressed between the grid and anode electrodes. Beam characteristics have been

investigated versus field strength near the cathode by changing voltage of grid pulses. Vacuum pressures achieved were in the order of  $10^{-6}$  Pa. Figure 6 shows anode current dependence measured at BC point, versus electric fields between the G-C. Figure 7 presents Fowler-Nordheim plot of the same data, where the symbol of  $E_{g-c}$  means that applied field strength between the G-C and  $\beta^2$ 's are field enhancement factors. Large values of  $\beta^2$ 's gotten from the plot indicate that field emission is the source of the beams as well as linearly changing dependence in the plot. The beam pulse shapes are shown in Fig. 8, which are measured by three kinds of monitors. The beam tests were performed with pulses of 65 ns width at a fixed repetition rate of 7 Hz. In Figures 6 and 7, the data measured before discharge occurred are shown with square marks, and ones with triangles are the data measured after discharge occurred three times serially. Although  $400 \text{ mA/cm}^2$  was obtained before discharge happened, the discharge between the G-C occurred occasionally, and whenever it happened, reduction in emission current took place. Estimating from the data in Fig. 6, the rate of reduction due to a discharge was about  $4 \sim 5 \%$  in intensity.

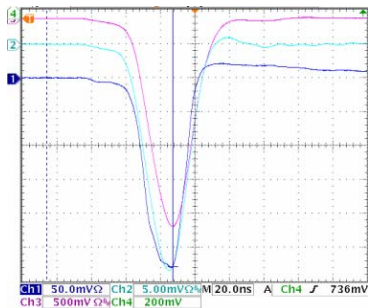

Figure 8: Monitor of beam current (CH1:WCM, CH2: CM, CH3:BC)

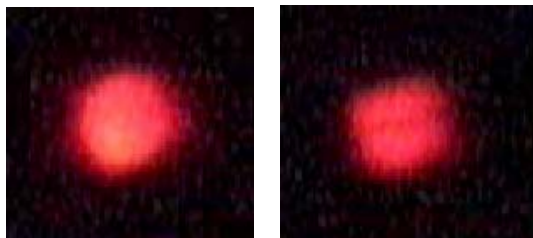

Figure 9: Beam shapes at BC before (a: left) and after discharge (b: right)

It is considered that CNTs sites emitting electrons might be broken by discharges, and number of site became fewer and fewer gradually. Then, in order to observe change in the beam shape the fluorescence screen was inserted instead of BC at the same place (see Fig. 9). The beam of Fig. 9a shows rather uniform shape which indicates uniform emission from the cathode. On the other hand, in Fig. 9b there is obviously a change in brightness: a portion of the beam disappeared due to discharges. The

cathode seems to be affected by discharges. It could be said that the beam shapes observed on the fluorescence screen reflects directly the state of cathode as they are.

## CNTS CATHODE SURFACE STUDY

In order to investigate directions for CNTs cathode optimization, the FE-SEM observation was performed. Figure 10 shows a FE-SEM image of a cathode sample used in this experiment, of which CNTs thin films produced on a SUS substrate. The FE-SEM observation was done in the secondary electron detection mode, at a working distance of 14.8 mm, with a probe current of  $10.6 \mu\text{A}$  at 10 kV accelerating voltage. CNTs can be seen near the center of the photograph. The EDS investigation was also done to check the materials of the concavo-convex parts around CNTs substances, which revealed the materials were mainly of spherical particles of carbon-like, and partly of un-grown up CNTs. In the investigated cathode, the quite large variations were observed in CNT density and height.

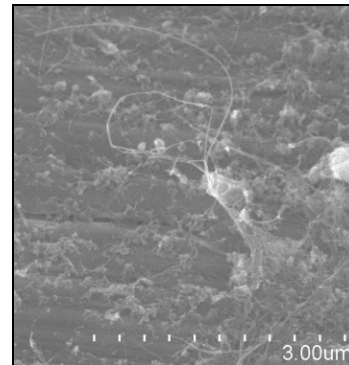

Figure 10: FE-SEM image of a CNTs cathode

## SUMMARY

Anode currents were obtained as high as 100 mA from CNTs cathodes, which were equivalent to the density about  $400 \text{ mA/cm}^2$ . It became promising that Ampere order beams would come true with some improvement in vacuum pressure and CNTs cathode structure.

## ACKNOWLEDGEMENTS

The FE-SEM work was conducted in AIST Nano-Processing Facility, supported by Nanotechnology Support Project of the Ministry of Education, Culture, Sports, Science and Technology (MEXT), Japan.

## REFERENCES

- [1] S. Ohsawa et al., *Proceedings of the 28<sup>th</sup> LINAC meetings in Japan*, pp. 120-122 (In Japanese).
- [2] A. Yamamoto et al., *Proceedings of the particle accelerator conference in America*, pp. 3326-3328 (2003).