

SuperKEKB 入射器における RF 電子銃用レーザー安定性と出力エネルギーの高性能化

IMPROVEMENT OF STABLE AND HIGH OUTPUT ENERGY LASER SYSTEM FOR RF-GUN AT SUPERKEKB INJECTOR

張叡^{#, A), B)}, 周翔宇^{A), B)}, 夏井拓也^{A), B)}, 吉田光宏^{A), B)}, 小川雄二郎^{A), B)}

Rui Zhang^{#, A), B)}, Xiangyu Zhou^{A), B)}, Takuya Natsui^{A), B)}, Mitsuhiro Yoshida^{A), B)}, Yujiro Ogawa^{A), B)}

^{A)} High Energy Accelerator Research Organization (KEK)

^{B)} The Graduate University of Advanced Studies (SOKENDAI)

Abstract

SuperKEKB project is aimed at the generation of electron beams with a charge of 5 nC and a normalized emittance of 10 μm at linac. According to these demands, an Ytterbium (Yb) laser system is selected for RF-gun. 1.5 nC electron charge has been achieved at 25 Hz for SuperKEKB phase I operation. For realizing 50 Hz laser operation and low emittance electron beam, the current laser is not suitable. Another new laser system is under building at new laser hut. Compare to the current laser system, new laser system is targeted at more simple, flexible and higher efficiency. Neodymium (Nd) laser system and Yb laser system are being built for different purpose. In order to get stable and high output energy laser system, improvements are made based on the operation situation of current laser system.

1. INTRODUCTION

SuperKEKB requires higher luminosity and lower emittance electron beam. In order to fulfill these demands, RF gun with strong electric focusing filed for high-current, low-emittance was adopted at linac. For generating electron beams with a charge of 5 nC and a normalized emittance of 10 μm by use of RF gun, according to the simulation of emittance due to the space charge effect, the ultraviolet (UV) laser source with a pulse width of several tens of picoseconds (ps) is required [1]. Furthermore, for reducing the energy spread, the laser pulse should be reshaped to rectangle from Gaussian shape [2].

For achieving the demands on the laser source, a hybrid laser system which consists of an Yb ions doped fiber oscillator, Yb-doped fiber amplifiers and thin disk Yb:YAG amplifiers. The laser system was tested at 25 Hz, 20 mJ fundamental laser pulse energy and 700 μJ UV pulse energy were obtained and 3.0 nC electron charge was gotten [3]. During SuperKEKB phase 1 commissioning, RF gun was selected for high energy ring (HER) injection about two weeks, 1.5 nC electron charge was generated and injected successfully and durably.

For the repetition rate of electron beam, 25 Hz with double bunches and 50 Hz are requested. As to current laser system, delay line for double bunch operation can't be realized because of space limit. Aim to build a more flexible and potential laser system, another new laser hut has been achieved at linac. Both Neodymium (Nd) doped laser system and Ytterbium (Yb) doped laser system has been being developed at the new laser hut. Nd doped laser system is a candidate for SuperKEKB phase II operation,

as for Yb doped laser system, it will be used for SuperKEKB phase III.

In order to realize effective and stable laser output, more excellent and efficient thermal management and amplification efficiency are explored, such as new thin disk laser head, low temperature laser operation and regenerative amplifier. All these improvements will be introduced in this proceeding.

2. LASER SYSTEM LAYOUT AT NEW LASER HUT

Compare to the current laser system, Nd doped laser system and Yb doped laser system are built simultaneously at new laser hut. One mode lock fiber laser oscillator is shared by two laser systems. For realizing backup for SuperKEKB, four seed lasers are prepared, as shown in Figure 1.

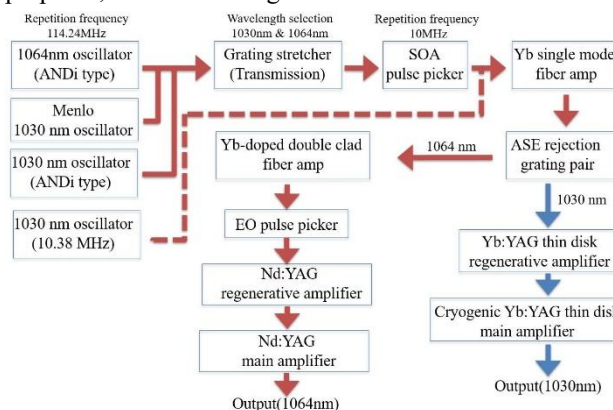

Figure 1: Layout of laser system for RF gun at new laser hut.

Figure 1 shows the layout of laser system for RF gun at

[#] rui.zhang@kek.jp

new laser hut. Three oscillators with 114.24 MHz are used as seed laser selectively, which is synchronized with the main trigger 2856 MHz at linac. Among them, Menlo fiber oscillator wavelength at 1030 nm has narrow spectrum so it can't be used as seed laser for Nd doped laser system with wavelength of 1064 nm. The other two homemade ANDi type oscillators are suitable to Nd laser system and Yb laser system at the same time. Recently, a 10.38 MHz fiber oscillator is being made for direct amplification in Yb doped single mode fiber without changing repetition rate. Seed laser is stretched into 30 ps bandwidth after a transmission grating stretcher, then amplified by semiconductor optical amplifier (SOA) accompanied repetition rate change from 114.24 MHz into 10 MHz. Subsequently, seed laser entered into Yb doped single mode fiber amplifier for both 1030 nm and 1064 nm. After this stage, different wavelength seed lasers can be selected and separated by an ASE rejection grating pair.

The 1030 nm seed laser is shifted into Yb:YAG thin disk regenerative amplifier by two flip mirrors, which are used to select 1030 nm amplification and 1064 nm laser amplification. In order to reduce stages numbers of multi-pass amplifier, the regenerative amplifier is very efficient to achieve almost 10^6 amplification factor. It has been demonstrated that the thin disk regenerative amplifier is available and effective to nanosecond and picosecond pulse laser [4]. The last stage for Yb doped laser system is cryogenic amplifier. At low temperature, higher gain and less amplification of spontaneous emission (ASE) can be gotten compared with room temperature. At room temperature the Yb^{3+} ion has a quasi-three level energy structure. A quasi-three level energy structure means that the lower laser level is not entirely depopulated in equilibrium. If the lower laser level has some population, then creating a population inversion is more difficult and requires more pump energy. If the lower level is depopulated in equilibrium and decays into the ground state, then the electronic structure is called a four level system. A four level system will be more efficient because less energy is necessary for a population inversion. In addition, other advantages of cryo-cooling the material include a reduction in the thermal expansion coefficient which leads to less thermally induced mechanical stress. Any mechanical stress in the material will cause wave front deterioration. Therefore, stable 1030 nm output laser with high beam quality can be achieved by more compact configuration compare with current laser system [5].

By use of the two flip mirrors, the 1064 nm laser can be injected into an Yb doped double clad fiber amplifier, then changed into 25 Hz or 50 Hz by an E.O. pulse picker. A custom designed Nd:YAG rod module is used for ring regenerative amplifier. The module can be operated under 25 Hz or 50 Hz with high amplification factor because small rod radius and high pump power. Another identical

module is used for main amplifier with two passes for seed laser.

After the final stages of amplification, 1030 nm and 1064 nm laser are converted into ultraviolet lasers by two nonlinear double frequency stages for injecting into RF gun. According to the plan, the 1064 nm laser system will be used for SuperKEKB phase II commissioning, the 1030 nm laser system will be adopted for phase III because laser pulse shaping is required for electron beam with low emittance [1].

3. IMPROVEMENTS OF THE 1030 NM YTTERBIUM DOPED LASER SYSTEM

3.1 Improved Au-Sn soldering Yb:YAG thin disk and copper block composite

As to current laser system at old laser hut, laser repetition rate has been updated from 2 Hz to 5 Hz and 25 Hz depending on the Yb:YAG thin disk and copper plate composite, which is combined by gold tin (AuSn) soldering [6]. Waste heat can be removed by the soldered Yb:YAG/Cu composite, so it can realize efficient thermal management and high repetition rate operation. However, the soldered composite must be adhered to copper heat sink by grease, it reduces the heat removal. In addition, residual stress is introduced by soldering. It causes the wave front deterioration and decreases the laser beam quality. Therefore, new copper block is designed and utilized for new Yb:YAG thin disk laser system.

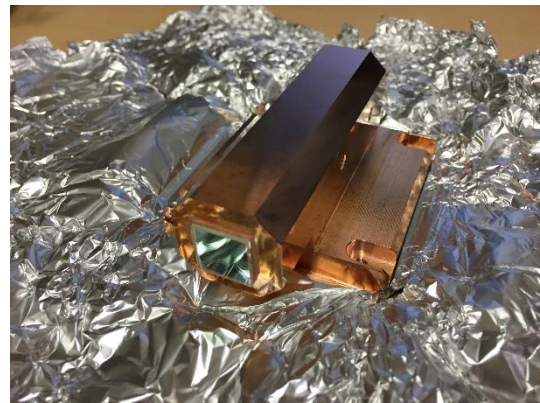

Figure 2: Achieved new Yb:YAG thin disk and copper block soldering composite.

The achieved new Yb:YAG thin disk and copper block soldering composite is shown in Figure 2. By replacing of the copper plate, the copper block was used. The square shape Yb:YAG disk with half an inch length and 1 mm thick, which is soldered onto a projection of Cu block. Special fixture is designed for providing pressure and fixing the Yb:YAG disk and Cu block. The soldering material is still AuSn as before because it processes many merits. Firstly, it has high thermal conductivity and low thermal expansion coefficient, as listed in Table 1. The thermal conductivity is high for AuSn comparing to that of indium-tin (InSn), this is very helpful for waste heat

removal. Secondly, the deformation of AuSn is weak on heating because its thermal expansion coefficient is comparably small. Meanwhile, it is evident from Table 1 that the thermal expansion coefficients of AuSn and copper are almost the same. Therefore, when laser is operating, the AuSn soldering layer and copper plate can expand synchronously to avoid fracture of the soldering layer as much as possible. Finally, AuSn possesses high resistant to corrosion and high creep resistance.

Table 1: Thermal Properties of AuSn, InSn, Cu, Yb:YAG and CuW

Material (ingredients of constituents)	Melting point (°C)	Thermal conductivity (W/m/K)	Thermal expansion coefficient ($10^{-6}/K$)
Au ₈₀ Sn ₂₀	280	58	16
In ₅₀ Sn ₅₀	118	34	20
Cu	-	396	16.4
Cu ₁₀ W ₉₀	-	190	6.3
Cu ₁₅ W ₉₅	-	200	7.0
Yb:YAG	-	6.8	6.8

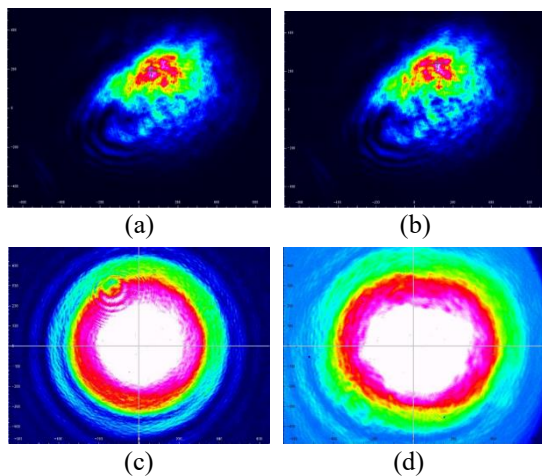

Figure 3: Reflected laser beam of a fundamental HeNe laser for optical measurement about soldering quality and thermal management. (a) and (b) are for old soldered composite, (c) and (d) are for new one.

Soldering quality and thermal management are tested for new soldering composite by use of an optical experimental setup. For comparison, test results of old design are also shown in Figure 3. As seen in Figure 3 (a), the reflected fundamental pattern helium neon laser beam is changed seriously, it demonstrates that the residual stress is strong that is introduced by soldering. As to (b), the reflected beam is tested under 3 J pump energy, it changes a little so waste heat is removed efficiently. About the soldering composite, the residual stress is much weaker than the old one, as shown in (c). Under 3 J pump,

the reflected test laser beam is changed, but the distortion is not serious. Therefore, by comparing with the old soldering design, the new one can achieve good thermal management and low residual stress for stable and high quality laser output.

Recently, new heatsink material is investigated. As listed in Table 1, Cu₁₅W₈₅ and Yb:YAG have the smallest difference for thermal expansion coefficient. It is very necessary to think about the different of thermal expansion coefficient for laser active material and heatsink, because the synchronous expansion can protect the Yb:YAG disk from fracturing, as well as the intactness of soldering layer.

3.2 Low temperature laser operation

At room temperature, Yb³⁺ ion has quasi-three level structure, so it has high laser threshold. As decreasing as the temperature, the lower level is depopulated in equilibrium and decays into the ground state, so the electron structure becomes four level structure. Low laser threshold and high gain can be obtained. Therefore, the low temperature laser operation is important. In addition, excellent thermal management can be realized for low temperature laser operation. As shown in Figure 4, a compact vacuum chamber is design for low temperature laser. Two pieces of Peltier plates are adopted as cooling device, the soldering Yb:YAG/Cu composite can also be used in the vacuum chamber. The achieved lowest temperature is -36 °C under full power operation of Peltier plates.

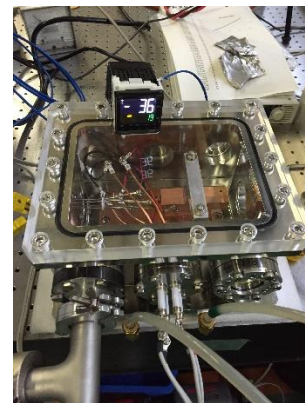

Figure 4: low temperature laser vacuum chamber.

In order to test the amplification factor under different temperature for seed laser with different wavelength, a homemade tunable fiber laser is used. As shown in Figure 5, the seed injects into the chamber from left side, then impinges into the Yb:YAG disk from side face. Pump laser emitted from laser diode stack is focused onto the front surface of the Yb:YAG disk, the active area is about 12.7 mm x 4 mm. By meticulous alignment, amplified seed laser can be measured during pump duration by a pin photodiode by filtering the powerful pump laser, then we can get the amplification factor by comparing with the seed laser without pump. The output power of seed laser is 10 mW, so accurate amplification can be tested below

saturation.

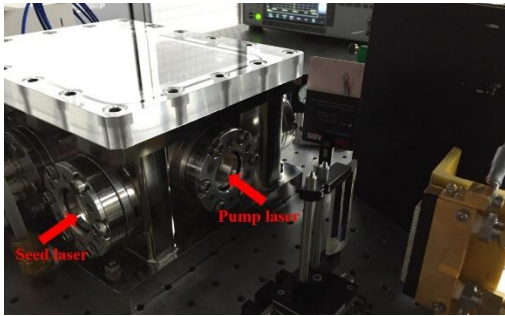

Figure 5: Experimental setup for low temperature laser amplification factor test.

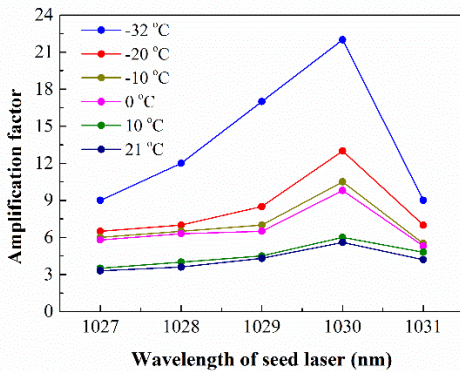

Figure 6: Amplification factor under different temperature for different wavelength seed laser.

As seen in Figure 6, the amplification factor at low temperature is much high than that at room temperature. For instance, the amplification factor at 1030 nm, absorption peak for Yb:YAG, is almost 5 times higher than that at ambient temperature. It demonstrates that more efficient amplification can be realized by this compact low temperature laser design. At the same, the thermal effect is much weaker than the current laser operation.

3.3 Regenerative amplifier

For nanosecond and picosecond pulse laser, regenerative amplifier is an effective candidate because it has very high amplification factor, our cooperator has achieved very stable and effective regenerative amplifier successfully, and the parameters of their laser system is similar with our new laser system design [4]. Therefore, it is necessary to adopt a regenerative amplifier as a preamplifier after fiber part.

A regenerative cavity has been designed, as shown in Figure 7. The seed laser comes from the fiber passes the combination of beam splitter, Faraday rotator and half wave plate, then enters into the amplification cavity. During Pockels cell on, the seed laser pulse can be trapped into the cavity and amplified many times. Two identical sets of telescope are places in the cavity for getting parallel beam and compensating the thermal lens

effect of Yb:YAG disk. The Yb:YAG/Cu soldering composite is used which is introduced in the above parts. Pump source is a 10 kW LD stack, active area is about 5 mm x 5 mm after a cylindrical lens and a dichromatic mirror. Calculated beam size inside the cavity is shown in Figure 8.

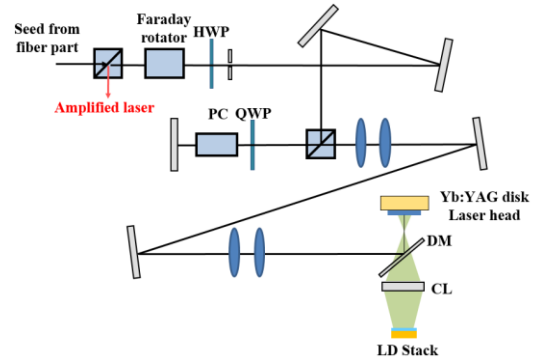

Figure 7: Regenerative amplifier cavity configuration.

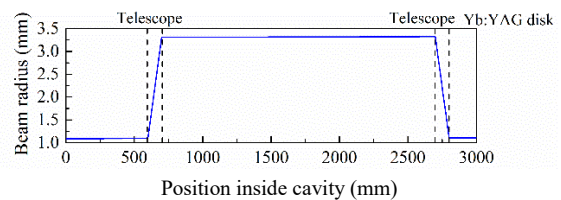

Figure 8: Beam radii in cavity shown in Figure 7.

The regenerative amplifier has been built and tested, the amplification of seed laser inside the cavity is monitored by a PD, which is behind a mirror for testing the leak laser, as shown in Figure 9. Amplification build up process inside the cavity can be seen clearly. However, output energy is not enough until now due to alignment and instable environmental problems. The experiment is under doing for achieving ~mJ amplified laser for cryogenic laser amplifier.

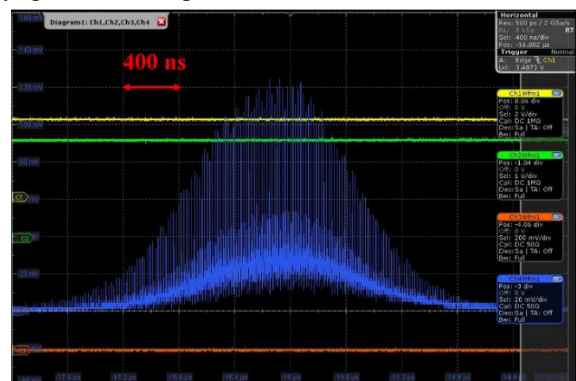

Figure 9: Amplification build up process inside the cavity.

4. CONCLUSION

Another new laser system is being built at another new laser hut based on the operation situation of current laser system. For realizing the demands of follow SuperKEKB phases, the new laser system should possess more

flexibilities. For example, it should have more space for double bunch operation layout and laser pulse shaping. Therefore, improvements of the laser system have been being done.

As to the solid part of new laser system, new soldering Yb:YAG disk and copper block composite is made for getting high beam quality output laser and low thermal effect. Meanwhile, this new soldering laser head is also used for low temperature laser operation. A compact vacuum chamber is designed, Peltier plates are adopted as cooling device. Theoretical analysis and experimental study indicate that the amplification factor is higher than that at room temperature. In addition, regenerative amplifier is designed and under building. In brief, all the efforts are being done for obtaining stable and high output energy laser system for RF gun of SuperKEKB.

REFERENCES

- [1] M. Yoshida, et al., "Longitudinal manipulation to obtain and keep the low emittance and high charge electron beam for SuperKEKB injector", Proceedings of IPAC 2013, China, Shanghai, May 13-17, 2013.
- [2] T. Natsui et al., "Quasi-Traveling Wave RF Gun and Beam Commissioning for SuperKEKB", Proceedings of IPAC 2015, USA, Richmond, May 3-8, 2015.
- [3] X. Zhou et al., "Ytterbium fiber and disk laser of RF Gun for SuperKEKB", Proceedings of IPAC 2015, Germany, Dresden, Jun 15-20, 2014.
- [4] M. Chyla, et al., "Optimization of beam quality and optical-to-optical efficiency of Yb:YAG thin-disk regenerative amplifier by pulsed pumping", *Opt. Letts.*, vol. 39, pp. 1441-1444, 2014.
- [5] M. Divoky, et al., "Overview of the HiLASE project: high average power pulsed DPSSL systems for research and industry", *High Power Laser Science and Engineering*, vol. 2, e14, pp. 1-10, 2014.
- [6] R. Zhang, et al., "Improvements of the Laser System for RF-Gun at SuperKEKB Injector", Proceedings of IPAC 2015, USA, Richmond, May 3-8, 2015.