

## DEVELOPMENT OF THREE-DIMENSIONAL SPIRAL INJECTION BY USING ELECTRON BEAM FOR MUON $g - 2$ /EDM EXPERIMENT \*

M. A. Rehman<sup>†</sup>, The Graduate University for Advanced Studies, Kanagawa 240-0193, Japan

H. Iinuma, Ibaraki University, Mito, Ibaraki, Japan,

S. Ohsawa, H. Nakayama, H. Hisamatsu, K. Furukawa, T. Mibe, High Energy Accelerator Research Organization, 1-1 Oho, Tsukuba, Ibaraki 305-0801, Japan

### Abstract

A novel three-dimensional spiral injection scheme by the use of electron beam is under development for new muon  $g - 2$ /EDM experiment at J-PARC which aims to measure  $(g - 2)_\mu$  to the accuracy of 0.1 ppm and muon EDM down to  $10^{-21}$  e.cm. Spiral Injection Test Experiment (SITE) is a scale down demonstration with the electron beam for the establishment of this new injection scheme. SITE is divided into the two stages. For the first stage, test experiment is utilizing an 80 keV DC beam from the thermionic electron gun and 83 gauss solenoidal storage magnet for the storage of electron beam into 24 cm diameter orbit. The goal of the first stage is to observe the electron beam as fluorescent light due to the excitation of nitrogen gas in the storage magnet. In the second stage of the SITE, pulsed electron beam will be stored in the median plane of the storage magnet for the order of milliseconds. Electric chopper system has been developed for the production of the pulsed electron beam. This paper will report the results from the first stage of experiment and development of electric chopper system for the second stage.

### INTRODUCTION

The muon's anomalous magnetic moment  $(g - 2)_\mu$  is one of most important measurement in elementary particle physics. The most recent measurement of  $(g - 2)_\mu$  results in  $3\sigma$  [1] discrepancy between measured and standard model prediction. In order to resolve current discrepancy the J-PARC new muon  $g - 2$ /EDM (E34) experiment aims to measure  $(g - 2)_\mu$  to the precision of 0.1 ppm and EDM down to the sensitivity of  $10^{-21}$  e.cm [2].

The key idea to measure  $(g - 2)_\mu$  is to store polarized muon beam in magnetic field and measure the evolution of spin precession vector with respect to time. In E34 a very low emittance ultra-cold muon beam of 300 MeV/c from muon accelerator will be injected into a 3-T Magnetic Resonance Imaging (MRI)-type solenoid magnet in order to store the muon beam in 0.66-m diameter orbit. A built-in radial field will vertically compress the helix of the muons as they approach to the mid-plane, then magnetic kicker a double anti-Helmholtz coils will remove the remaining vertical momentum of the muons, hence muons will store in the mid-plane. The detail study of spiral injection scheme has been published in [3].

A demonstration experiment to prove the feasibility of this newly proposed scheme is inevitable. Therefore, a

scale down Spiral Injection Test Experiment (SITE) by the use of electron beam is under development at KEK Tsukuba campus. SITE is divided into stages. The first stage goal of SITE is to detect a DC electron beam spiral track in the storage chamber as fluorescent light from  $N_2$  gas excitation along the electron beam path. In the second stage of SITE, pulsed electron beam will be stored in the median plane of the storage magnet for the order of few milliseconds. The development of pulse electron beam has already been started. Comparison of parameters between E34 and SITE are given in Table 1.

Table 1: Comparison of Parameters between E34 and SITE

Parameters	E34	SITE
Storage magnet field strength	3 T	0.0083 T
Beam particle	$\mu^+$	$e^-$
Magnet type	Super conducting	Normal conducting
Field uniformity	1 ppm	100 ppm
Momentum	300 [MeV/c]	0.296 [MeV/c]
Cyclotron Period	7.4 nsec	5.0 nsec
Storage Orbit diameter	0.66 m	0.24 m

### SPIRAL INJECTION TEST EXPERIMENT BY USING ELECTRON BEAM

Figure 1 represent the entire beam line and storage magnet of SITE. Beam line is 2 m long including electron gun and the height of solenoidal magnet is 1.9 m from the ground. At the beginning of the beam line a DC thermionic electron gun of 80 keV is used to produce an electron beam. A magnetic lens at the distance of 70 mm away from the electron gun serves as a focusing element for the electron beam in the straight section. A collimator of 3 mm diameter and length of 5 mm is placed at 700 mm away from electron gun to control the beam halo in a drift section of straight beam line and also used to maintain the differential vacuum for storage magnet. A dipole magnet on the straight beam line is used to bend the electron beam into the storage magnet. To control the transverse position ( $x - y$ ) of electron beam, five pairs of steering coils have been installed on the beam line. Three fluorescent screen (FS) monitors have been placed to detect transverse profile of

\*Work supported by the "Grant in Aid" for Scientific Research, JSPS (KAKENHI#26287055)

<sup>†</sup>rehman@post.kek.jp

the electron beam along beam line. The initial results of beam line has been published in [4].

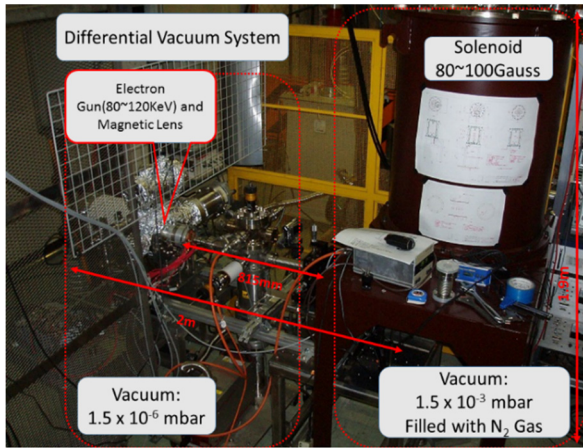

Figure 1: Photo of SITE setup.

### STORAGE MAGNET

Storage magnet is a solenoidal electromagnet placed inside a cylindrical iron yoke of height 800 mm and diameter of 600 mm, the thickness of iron yoke is 5 mm. Top and bottom sides of the iron yoke are closed by 20 mm thick iron plate to avoid field leakage from the storage magnet. The iron poles of 120 mm height and thickness 20 mm are placed at the centre of the top and bottom iron plates. Both upper and lower iron plates have four viewing windows. Upper windows are used to install CCD camera, vacuum valve and feed through for fluorescent plate. Lower windows will serve to inject electron beam and diagnostic components.

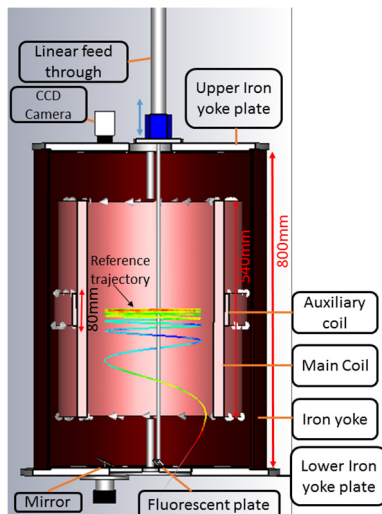

Figure 2: Schematic view of storage magnet with reference trajectory and monitors.

A vacuum chamber of height 680 mm and diameter of 400 mm is installed inside the storage magnet to store electron beam. Figure 2 is showing the schematic of storage magnet with reference trajectory and dimensions of coils and iron yoke.

In order to observe electron beam as fluorescent light storage chamber was filled with the nitrogen gas. When electron beam collides with the nitrogen gas, some molecules are ionized and some undergoes the excitation. De excitation of nitrogen molecules results in the emission of fluorescent light in the visible wavelength of the range ( $390 \text{ nm} < \lambda < 470 \text{ nm}$ ). A CCD-camera is used to observe fluorescence light from the nitrogen gas de excitation.

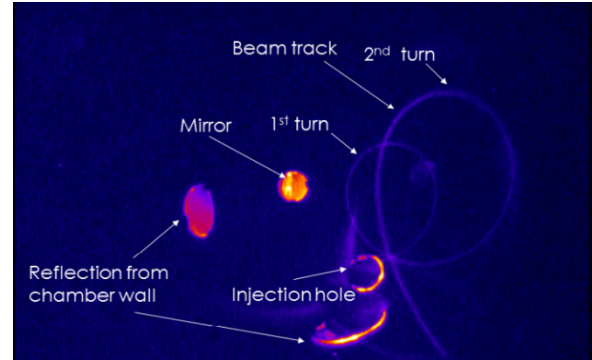

Figure 3: Electron beam track in the nitrogen gas. Two turns of beam track were observed clearly. False colours are added to the original black and white image for better visibility.

After performing the several injection angle studies two turns were observed clearly. Figure 3 is the result of the nitrogen gas monitor which shows two turns of electron beam as fluorescent light nitrogen gas. In order to avoid light reflection the storage chamber walls will be blackened by graphite paint.

### ELECTRIC CHOPPER SYSTEM

For the second stage of the SITE, development of pulsed electron beam has been started. Fast response, simple structure and low cost make electric chopper system best choice for the generation of the pulsed beam. Electric chopper has been designed, simulated and fabricated to produce the pulsed electron beam for the second stage of the SITE.

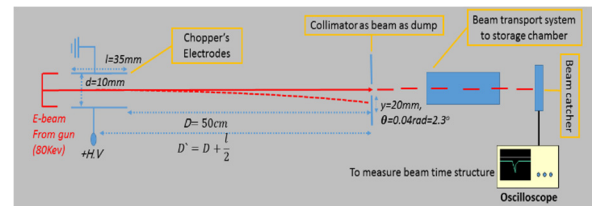

Figure 4: Schematic layout of electric chopper system.

The chopper voltage depends on the electron beam energy, the distance, and length of the plates and on the beam stop location. The required deflection voltage can be calculated by the following equation

$$V_d = \frac{\theta(\gamma mc^2)\beta^2}{l} d$$

Where  $V_d$  is the deflecting voltage,  $l$  is the length of plate,  $\theta$  is required deflection angle,  $d$  is the gap length.  $\gamma$  and  $\beta$  are relativistic factor of the beam.

The chopper system design and geometry are resulted on the electrode length of 35 mm and mutual separation between electrodes plates are 10 mm. The collimator to control beam halo and for differential vacuum system will serve as a beam dumper for chopper system. The electron beam of 80 keV will be deflected on the collimator at a distance of 20 mm, which corresponds to the deflection angle of 0.04 rad, which require deviating voltage of 1.6 kV. Schematic layout of chopper system is given in Fig. 4. Table 2 shows the parameters for the chopper system.

Table 2: Parameters for the Chopper System

Parameters	Values
Injected beam energy	80 keV
Chopper deflecting voltages	1.6 kV
Pulse rise and fall time	< 25 ns
Pulse width	50 ns
Frequency	50 Hz

### Mechanical Design

A cross beam pipe of asymmetric diameter is used to host the electrodes. Bigger diameter pipe is used for the insertion of chopper's electrodes. Each electrode is consist of a plate of 3 mm thick stainless steel sheet supported by two ceramic column. They are inserted from opposite sides and their vacuum flange supports each other. The ground

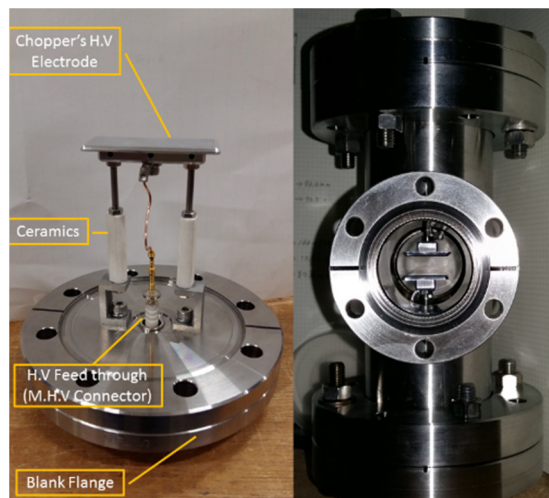

Figure 5: Left: H.V electrode and its support. Right: Electric chopper's electrodes in vacuum chamber

electrode is directly connected to the flange while the polarized plate is welded to the Miniature High Voltage (MHV) feed-through connector. Figure 5 (Left) presents the support structure and feed through connection to the H.V plate, Right is showing the cross section of electrodes assembly in the vacuum chamber. The ceramic feed

through is a standard 5 kV single ended coaxial MHV connector.

### CST Simulation

In order to check electric field profile and examine the effect of the maximum electric field on vacuum chamber walls, simulation of chopper system has been carried out in CST-EM [5] studio, 1.6 kV was applied to the lower electrode plate while upper plate and vacuum chamber were at ground potential. Figure 6 shows the potential contours over cross section of chopper system. The equipotential lines near high voltage electrode are dense which indicates a large electric field in the z direction. Maximum field calculated from analytical formula and from simulation are in agreement with each other.

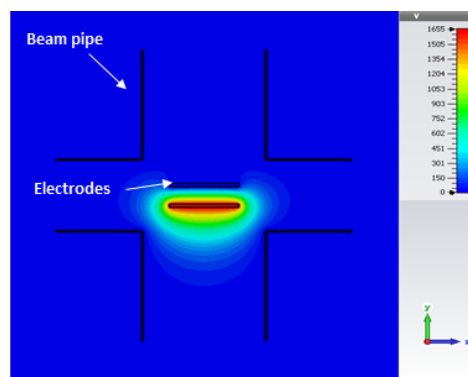

Figure 6: Potential contours on the cross section of the chopper's electrodes and beam pipe.

### Electrical Design

The schematic of electrical design of the electric chopper system is presented in Fig. 7. The high voltage power supply is connected to pulse generator, which acts as a switch. Pulse generator alternatively connects the H.V electrode to ground and to the positive or negative high voltage power supply [6] following the timing signal, repetition rate and pulse width from a function generator (trigger).

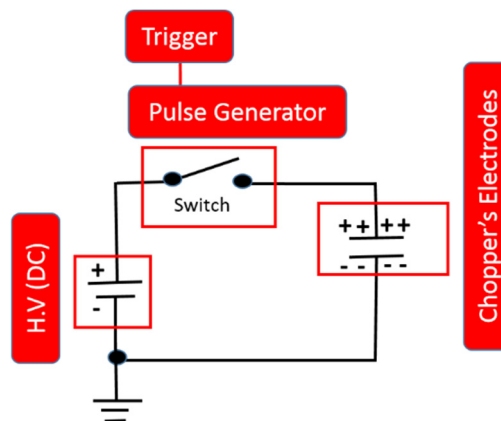

Figure 7: Electrical design of the chopper system.

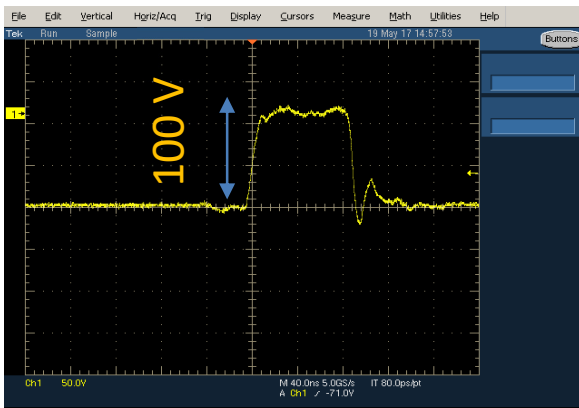

Figure 8: Output from PVX 4140 pulse generator at 100 V.

The key component of chopper system is PVX 4140 [7] pulse generator. Agilent 81101A [8] function generator is used to feed timing signal for pulse generator. Figure 8 presents the output of PVX 4140 pulse generator at 100 V. All major components of the chopper system are ready and they will be installed on the beam line soon to produce pulsed beam.

## SUMMARY

Three-dimensional spiral injection is one of a key idea for the new J-PARC muon  $g - 2$ /EDM experiment. For the establishment of this novel scheme, the Spiral Injection Test Experiment (SITE) by the use of the electron beam is under development at KEK Tsukuba campus. SITE is divided into two stages. The first stage goal is to detect a DC electron beam spiral track in the storage magnet as fluorescent light from nitrogen gas excitation along the electron beam path. Two turns of electron beam as fluorescent light from the nitrogen gas monitor were observed clearly. The second stage and final goal is to store pulsed electron beam for the order of milliseconds. The development of the electric chopper system to produce pulse electron beam has been started. Electric chopper system mechanical and electrical design are finalized. Electric chopper system is almost ready to install on the beam line to produce pulse electron beam.

## REFERENCES

- [1] G.W. Bennett *et al.*, “Final Report of the muon E821 anomalous magnetic moment measurement at BNL”, *Phy. Rev. D.*, vol. 73, p. 072003, 2006.
- [2] M. Aoki *et al.*, Conceptual Design Report for The measurement of the Muon Anomalous Moment  $g - 2$  and Electric Dipole moment at J-PARC (2011).
- [3] H. Iinuma *et al.*, “Three-dimensional spiral injection scheme for the  $g-2$ /EDM experiment at J-PARC” *Nucl. Instr. Meth.*, Vol. A832, pp. 51-62, 2016.
- [4] M.A. Rehman *et al.*, “Test Experiment of 3-D spiral injection scheme using electron beam for new  $g - 2$ /edm experiment at j-parc” in Proc. of the 13th Annual Meeting of Particle Accelerator Society of Japan (PSAJ’16), Chiba, Japan, Aug. 2016, paper TUP056, pp. 1004-1007.
- [5] <http://www.cst.com>
- [6] <http://www.matsusada.com>

[7] PVX 4140; <http://www.ixyscolorado.com>

[8] Agilent 81101A; <http://www.keysight.com>