

A BEAM-LOSS MONITORING SYSTEM AT KEK

H. Nakagawa, S. Shibata, S. Hiramatsu, K. Uchino and T. Takashima
National Laboratory for High Energy Physics
Oho-machi, Tsukuba-gun, Ibaraki-ken, 305, Japan

1. Introduction

The beam-loss monitoring system with free-air ionization chambers was installed in the Main Ring at KEK to get both spatial and temporal information of beam losses. Two beam-loss monitoring systems were used at KEK, scintillation counter type detectors and ionization chambers with an argon mixture¹⁾. They had some troubles, careful maintenance was required. New system is almost maintenance-free, because the material for ionize does not worsen and there are no active electronic components in the tunnel. The signal processor is advanced, the amount of beam losses can easily be measured. This system can observe the beam-loss distribution varying with time in one cycle.

2. Monitoring system

The beam-loss detector of free-air ionization chamber has 0.5ms resolution, about 200 μ A saturation of current at HT=500V. One detector, the type is called long radiation monitor²⁾, covers half cell (6m) and 56 chambers cover all of the Main Ring. The signals from 56 chambers are integrated independently and operator or computer can read out at arbitrary timing without destroy the information. We can also observe the integrated signal continuously at any point. The system diagram is shown in fig.1.

The data from this system are³⁾ processed and displayed on graphic terminal by MELCOM-70 computer network.

3. Observation

Fig.2 (a)~(e) show beam-loss distributions which change at times. In this accelerator, typical beam losses happen 4 times in one cycle, injection, acceleration start, phase transition, extraction. These 4 beam-loss patterns are almost stationary. Sometimes, machine trouble, misoperation or mistuning cause different beam-loss distribution.

At the injection there were some beam losses in normal operation as shown in fig.2(a). At the acceleration start there were no beam losses in normal operation. For example, beam losses caused by RF-station trouble are shown in fig.2(b). At the phase transition beam losses occur at 5F Q-magnets of each superperiod, where horizontal dispersion function becomes maximum. Usually, maximum beam-loss location is 5F of superperiod I as shown in fig.2(c). When tuning of accelerator was not good, beam-loss location altered other 5F, as shown in fig.2(d). At the extraction it seems that the cause of beam losses is extraction septum. Beam losses exist locally at near 1D Q-magnet of superperiod II and III, where extraction septa were installed, as shown in fig.2(e). We can estimate the extraction efficiency from this data.

This system can also be used to study of the machine. Fig.3 shows the integrated signal of beam losses caused by phase transition at I-5F where the beam losses are most heavy⁴⁾ at the time. The data is compared with the signal from a wall current monitor⁴⁾ which shows longitudinal distribution of bunch. It seems that the beam losses at phase transition depend on longitudinal distribution of bunches.

From the facts described above, this monitoring system is very powerful for operation and studies of the machine.

Reference

- 1) S. Hiramatsu et al. 2nd Symp. on Accelerator Science and Technology, Tokyo (1979) P.127.
- 2) R.L. Witkover IEEE Trans. Nucl. Sci. NS-26 (1979) 3313.
- 3) T. Katoh et al. IEEE Trans. Nucl. Sci. NS-24 (1977) 1789.
- 4) H. Nakagawa et al. 2nd Symp. on Accelerator Science and Technology, Tokyo (1979) P.117.

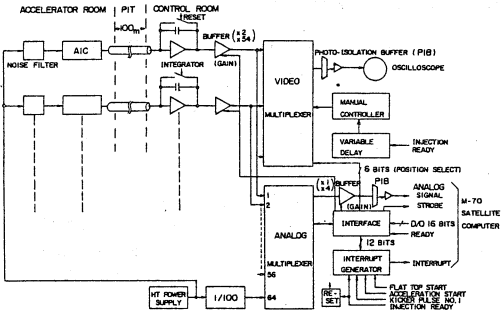

Fig.1 Block diagram of system.

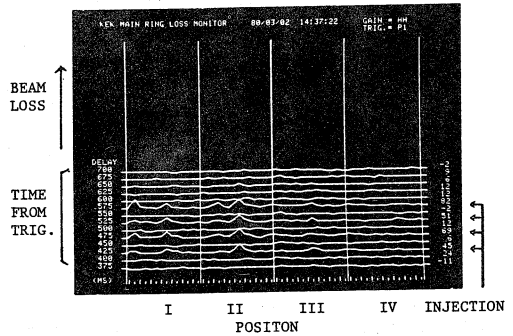

Fig.2 (a) Beam losses at injection.

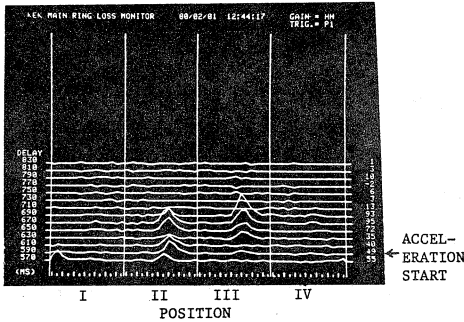

Fig.2 (b) Beam losses at acceleration start when one of the RF-station could not run.

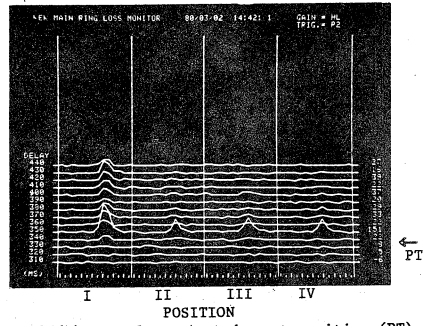

Fig.2 (c) Beam losses at phase transition (PT) in usual condition.

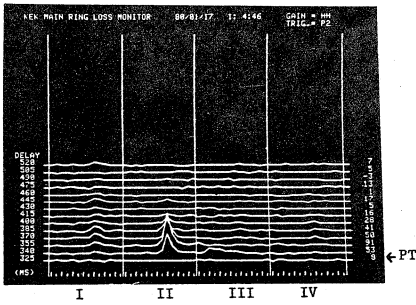

Fig.2 (d) Beam losses at phase transition when tuning is not good.

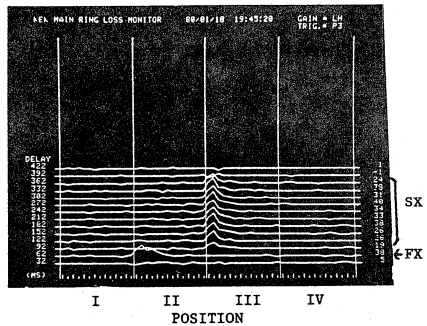

Fig.2 (e) Beam losses at extraction.

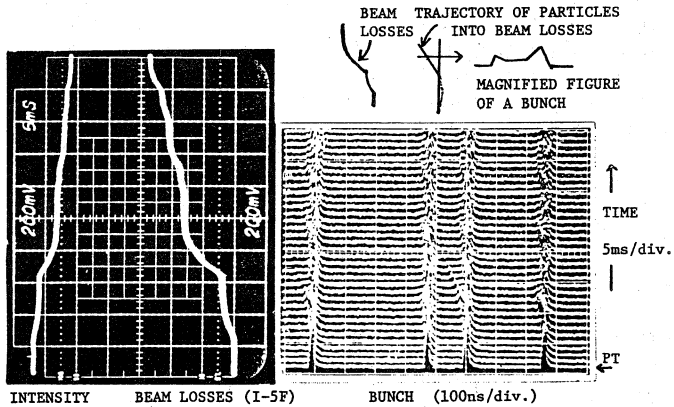

Fig.3 Beam losses and bunch shape.