

PRESENT STATUS OF KEK POLARIZED ION SOURCE

Kiyoshi IKEGAMI, Yoshiharu MORI, Akira TAKAGI and Sadayoshi FUKUMOTO
National Laboratory for High Energy Physics
Oho-machi, Tsukuba-gun, Ibaraki-ken, 305, Japan

ABSTRACT

Some improvements were made to the KEK optically pumped polarized H⁻ ion source for long term operation. They include stabilization of the pumping laser and modification of the ECR ion source. The source worked well for test acceleration of the polarized beam in Linac and Booster.

INTRODUCTION

An optically pumped polarized ion source has been developed at KEK¹⁾. Recently, it was operated and a beam of 2 μA was accelerated to 20 MeV with polarization of 40%. The ion source was improved for the operation as follows: a solenoid of the ECR ion source with magnetic shield was installed to avoid leakage magnetic flux at the zero-crossing region, multi-cusp magnetic field was introduced into the ECR cavity and the inside surface of the cavity was covered with quartz to increase the plasma density, several accelerating electrodes were tested and a satisfactory one was selected from a point of view of its life time and the beam intensity, a sodium cell for negative ion production was replaced by a recycling system so that sodium consumption was greatly reduced and the ring dye laser, which pumps sodium atoms, was equipped with a personal computer feed back system to stabilize its frequency and it has worked reliably for long term operation.

STABILIZATION OF RING DYE LASER

Polarized H⁻ beams were accelerated by the 20 MeV Injector Linac of the KEK 12 GeV Proton Synchrotron in October 1983 and in the period from the end of February to the beginning of March 1984. A schematic diagram of the optically pumped polarized ion source is shown in Fig. 1. Sodium atoms are electron-polarized by laser light in the source²⁾. We use two single-frequency-mode ring dye lasers for the purpose, they are adjusted so that their frequencies are little bit different each other but both are in the resonance band of 3 GHz of the sodium D1 line. There are in the clean room with the air filter. The output power of each laser is 1.5

W. The frequencies of the lasers should be constant for long term operation, so that a control system was developed to avoid frequency changes due to mode hop or others. It has a personal computer to stabilize the laser frequency, a detector of the laser beam position and a mirror control for adjustment of the laser beam position. Figure 2 is the control system. Figure 3 shows the outputs of the personal computer, one with feedback and the other without feedback. Its time scale is about one hour. Fluctuation of the wavelength of the laser is in ± 0.01 cm⁻¹ by the system. Figure 4 shows variation of the wavelength for three days.

IMPROVEMENT OF ECR ION SOURCE

An ECR ion source is used as a proton source. 1 ~ 2 KW microwave of 16.5 GHz is fed to the ECR cavity axially through a quartz window. Permanent magnets are attached to the inside surface of the cavity to produce multi-cusp magnetic field and they are separated from plasma by a quartz cylinder. Observed electron temperature of the plasma was 23 eV³⁾. Its proton ratio increased to 85% whereas its operating gas pressure decreased to 50%. Noise in beam is reduced as shown in Fig. 5.

Beam intensity is 2 mA at the exit of the charge-exchange cell for production of H⁻. The beam hole diameter of the ECR source extracting system, which consists of three electrodes, is 4 mm. These are multi-slits and the last one has parallel 0.1 mm diameter tungsten wires, which are supported at one end to eliminate deformation caused by heavy beam loading. An accelerating voltage of 5 kV is applied in pulse mode of 20 Hz to avoid breakdown. Both the beam intensity and the electrode life are improved by this configuration.

Solenoid of the ECR was replaced by one with magnetic shield. Its maximum field is 10 kGauss. Leakage magnetic field is reduced so that the field gradient is less than 2 Gauss/cm at the zero-crossing region.

H⁻ ions are produced by charge-exchange with sodium atoms. To reduce sodium consumption, a recycling system was introduced. Keeping wall trap temperature suitably, condensed sodium at the wall trap

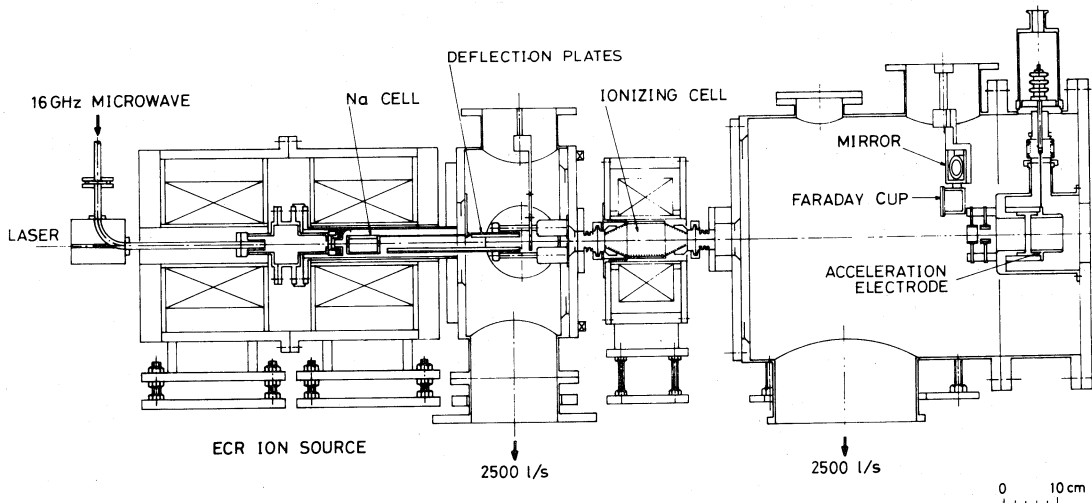

Fig. 1 Schematic-layout of the optically pumped polarized H⁻ ion source.

flows through the mesh on the wall and goes back to boiler. The temperatures are regulated by an ON-OFF control system with sufficient accuracy.

ACCELERATION OF POLARIZED BEAM

Figure 7 shows the polarized H^- beam intensity. Beam intensity and polarization are measured as a function of the beam size (Fig. 8). To define the beam diameter, a circular collimator was put at the entrance of the H^- charge-exchange cell. Polarization was measured by a monitor after acceleration to 500 MeV by Booster Synchrotron⁴. It showed that the beam intensity and the polarization did not significantly depend on the beam size. Therefore, it seemed that a central part of the source beam passed Linac. Some improvement of the beam intensity is expected by shorting the distance between the H^- charge-exchange cell and the acceleration electrode. Polarization is degraded by background hydrogen. This is the problem to be solved in near future.

REFERENCES

- 1) Y. Mori et al., AIP Conf. Proc. No.117, 123 (1984).
- 2) L.W. Anderson, Nucl. Instrum. Meth., 167, 363 (1979).
- 3) A. Takagi et al., Proc. of 4th Symp. on Accelerator Science and Technology (1982) 229.
- 4) S. Hiramatsu et al., KEK 83-28 (1984).

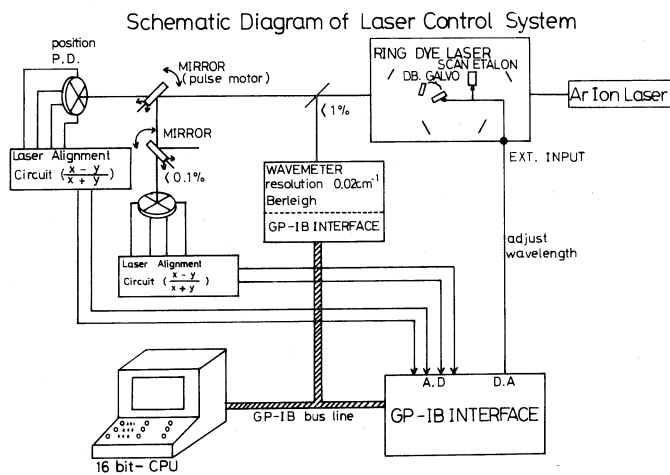
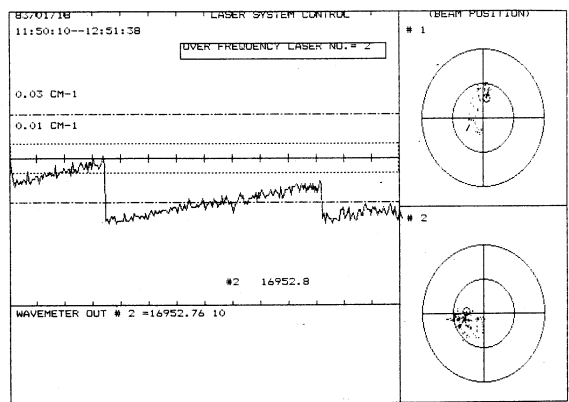

Fig. 2 Schematic diagram of laser control system.

(A) non-feedback



(B) feedback

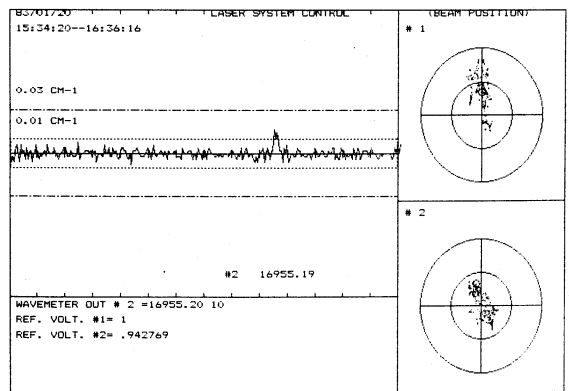

Fig. 3 Output of the personal computer for laser control system.

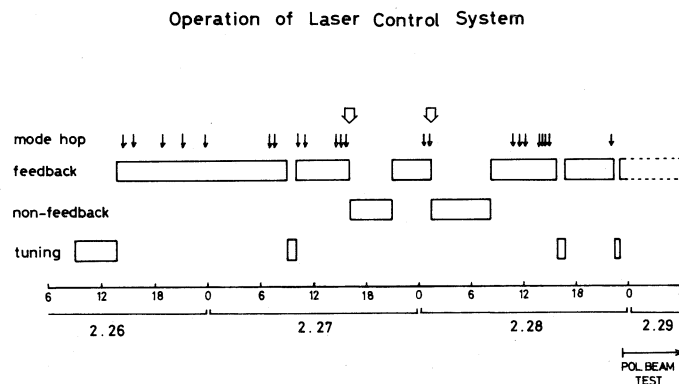

Fig. 4 Summary of three days operation of laser control system in February in 1984.

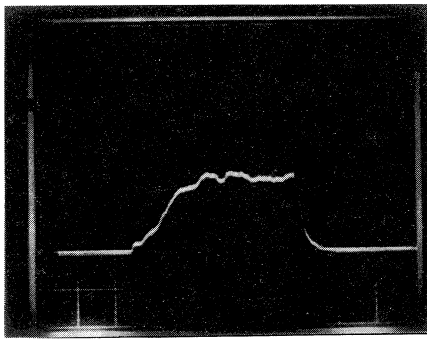

Fig. 5 Ion beam current of ECR ion source by faraday cup placed just before acceleration electrode.

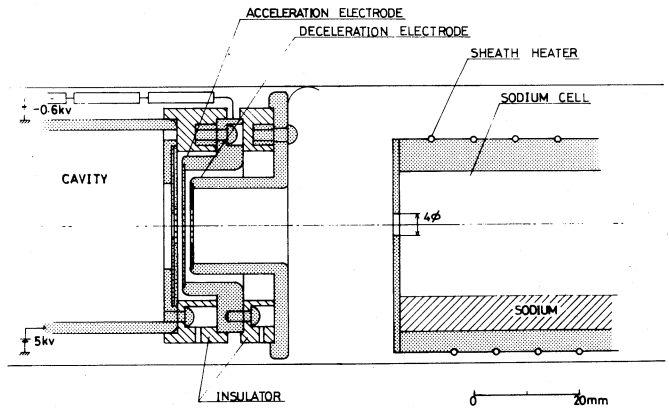

Fig. 6 Schematic-layout of the ECR ion source extracting system.

POLARIZED H^- BEAM AT KEK

BEAM INTENSITY

CM-1 (after 750 keV acceleration column)	21 μA
CM-6 (entrance of 20 MeV Linac)	7 μA
IM-1 (after 20 MeV Linac)	2 μA

BEAM POLARIZATION AT 20 MeV BEAM LINE

$P = 46.3 \pm 4.6 \%$

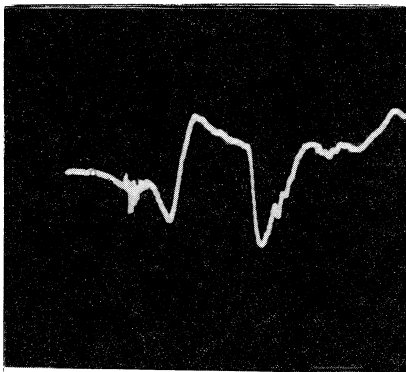

Polarized 20 MeV beam by intensity monitor IM-1.

Fig. 7 Record of polarized H^- beam (Feb. - Mar. 1984).

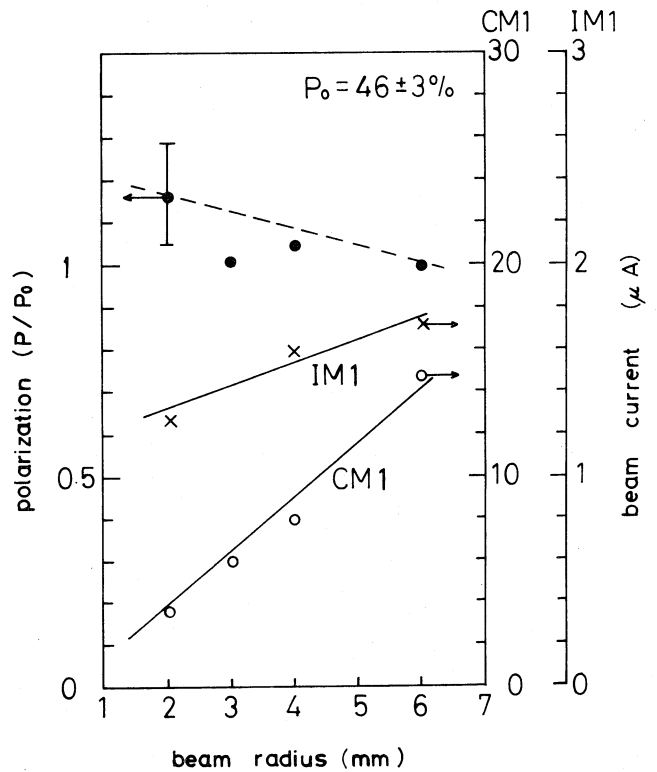

Fig. 8 Dependence of polarizations and beam currents on beam sizes at the output of polarized ion source. CM1 shows the current just after 750 keV acceleration whereas IM1 is 20 MeV Linac beam.