

HIGH GRADIENT ACCELERATION BY RECIRCULATOR

I. Sato, K. Nakahara, A. Enomoto, T. Ohsawa, U. Ogawa, T. Ohgoe
 H. Kakihara, H. Hanaki, K. Furukawa, S. Fukuda and S. Anami
 Laboratory for High Energy Physics

N. Yamaguchi, K. Inoue, Y. Iino, U. Kamouchi
 Y. Tsuchiya, K. Taki and S. Fujie
 Mitsubishi Heavy Industries, Ltd.

ABSTRACT

High gradient acceleration was attempted in a tentative way by use a conventional short accelerator guide. In this trial we succeeded in the acceleration of electron beam of 18.2 MeV using the given rf power of 26 MW. The average of accelerating electric field in the guide was estimated about 60 MV/m.

INTRODUCTION

We are promoting a development of high gradient acceleration for a practical application of a compact linac, for increasing of positron beam capture and etc. Approach for high gradient acceleration have been proposed by many kind of methods. SLAC have actually realized high gradient acceleration over 20 MV/m using SLED method¹⁾.

Ours first approach for high gradient acceleration is to search the accelerating limit of the electron beam using an ordinary microwave source(25MW) and a conventional diskloaded traveling wave guide²⁾. So, ours first trial have generated gradient field of 50MV/m and have actually accelerated electron beam. For this trial, we selected a microwave recirculating method for an acceleration system. Because the accelerating electric field of the recirculating system with an accelerator guide of the traveling wave type is higher than that of a standing wave accelerator system with the same structure guide on condition of the same given rf power.

SLAC in 1986 realized 58MV/m (accelerating field) at the first accelerating cavity of a 1.5m accelerator guide with the SLED³⁾, and then an average field of 48MV/m with the supplied rf of 33MW. Though accelerating test by beam only realize maximum 25MV/m up to now because of electric discharge etc....

As back ground of high field accelerating there are high gradient studies by advanced developments for some linear collider projects. These studies generated only high electric field by to supply high power to a high impedance accelerator guide. KEK's⁴⁾ method is different from SLAC's⁵⁾. The results of these studies recorded 104.5MV/m⁶⁾ and 146MV/m⁷⁾ respectively, it's field strength on the center axis of the accelerator guide.

RECIRCULATING ACCELERATOR

This system consists of an accelerator guide, and some waveguide with a directional coupler guide. And those components are arranged a ring like as are combined the input coupler cavity the output coupler cavi-

ty of the guide with those waveguide. When the rf power is supplied to the system through the directional coupler, and then the given wave circulate periodically in the system, the power shall be accumulated gradually in the system and increase colossally the amplitude of forward wave in the guide. Namely, the microwave through the accelerator guide is reclaimed to return synchronously again to its input coupler cavity by the waveguide. Then this system completely utilizes microwave power for generating the accelerating field.

The layout of the system is showed by Fig.1. The detail of accelerator guide is showed by Fig.2.

For making a compact accelerator practicable, it needs both high accelerating field and large energy gain. Under the limitation that a supplied power is constant, the more the electric field increase, the more the energy gain decrease. And under the limitation that the pulse width of the given power is constant, if it is required to increase the accelerating field, it is to increase the number of rounds of the rf power in the system. And it is realized by shortened a filling time of the accelerator guide. So it is to shorten the guide. On the other hand if it is required to increase energy gain, it is to lengthen the guide. For satisfying of the contradictory two requirements, it needs for the accelerator guide to have such characteristics as high shunt impedance and high group velocity, though this two the characteristics are the contradiction, too. And we selected $\pi/2$ phase shift mode for the guide structure so it has the highest group velocity and comparatively high shunt impedance.

Constructive specifications and parameters of accelerator guide are showed by Table 1. The energy gain and the accelerating field strength when 25 MW RF power was supplied are showed by Table 2.

Table 1 Specification of acceleration system
 Accelerator guide

Type	constant impedance
Phase shift	$\pi/2$
Operating frequency (Mhz)	2856
Accelerating cavity	13
Length of accelerator guide (cm)	30.4
Aperture of diskhole (mm)	20.0
Shunt impedance (Mohm/m)	50.0
Group velocity (Vg/c)	0.0098
Factor of merit Q	11000

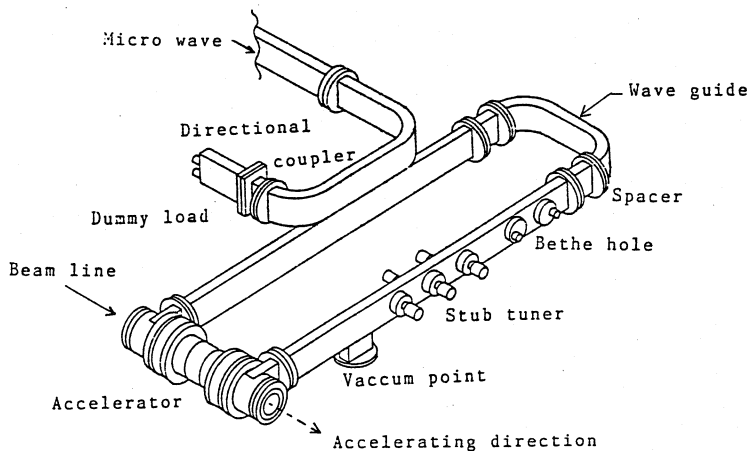

Fig.1. High gradient acceleration system of recirculator type.

Field attenuation (neper/m)	0.277
Power attenuation (dB)	0.822
Filling time (nS)	116.1

Recirculator	
Total length of waveguide (m)	2.9
Power attenuation of waveguide (dB)	0.06
Total power attenuation (dB)	0.882
Field coupling factor for directional coupler (dB)	14.7
Power amplitude (dB)	7.35
Recirculating time (nS)	130.2

Table 2 Specification for energy gain and accelerating field strength

Supplying power (MW)	25.0
Energy gain (MeV)	19.0
Accelerating field strength (MV/m)	58.5

gradient in the guide is calculated by the energy gain and available length of the guide. The energy gain of the guide was measured three times (each different rf power). Fig.4(a)(b)(c) is energy spectrum for the given rf powers of 18, 24 and 26 MW, respectively. Photo.1 is the output signal of a directional coupler attached to the waveguide of the recirculation ring.

This signal expresses the traveling wave form of rounding the recirculation ring, and expresses the state that the traveling wave piles up gradually. The energy gain and test condition calculated by result of the test is showed by Table.3. On one hand, the route relation of the energy gain and supplied power is showed, too. From parameter of the accelerator guide the accelerating field gradient on the accelerator axis (E_f) and the rounding power (P_a) is calculated as follows.

$$E_f(\text{MV/m}) = 5.27 P_a^{1/2}$$

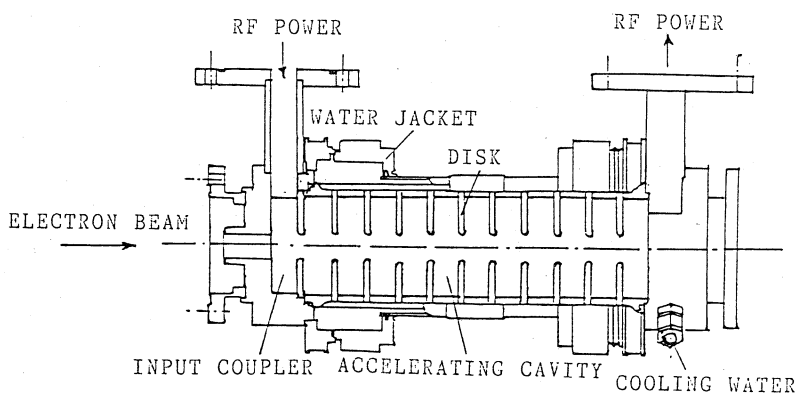

Fig. 2. Cross-section of the traveling wave disk-loaded accelerator guide of the $\pi/2$ phase shift type.

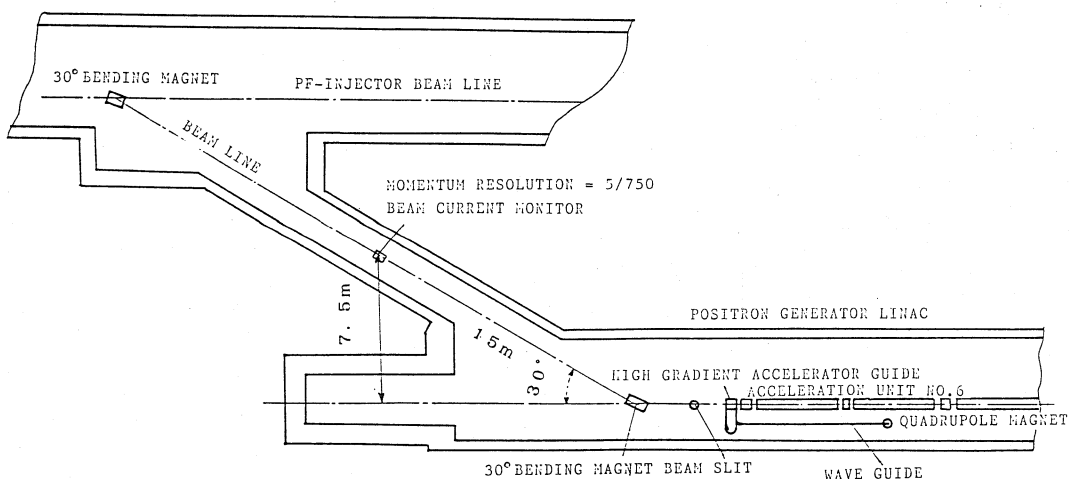

Fig. 3. Layout of the high gradient acceleration experiment

TEST OF HIGH GRADIENT ACCELERATION

The high gradient acceleration system is set up the end of e^+ linac's beam line, the microwave power to this system is supplied through a waveguide from RF source (P6 unit) at the e^+ linac's end. Arrangement at the test of high gradient acceleration is showed by Fig. 3.

Electron used this test is the beam as a short pulse (2.2A, 4nsec). The energy spectrum of the accelerated electron beam have been measured by a bending magnet at the down stream. To increase the measuring accuracy, we measured both energy spectrum of electron beams on the accelerating phase of the system and on the decelerating phase, respectively. We decided the energy gain of the accelerator guide in the system is half of the measured energy difference. The accelerating field

Table 3 Comparison with energy gains and experimental data

Exp.No	Pk (MW)	Pac (MW)	Eac (MeV)	Ef (MV/m)	Eacx/Eacl	(Pkx/Pk1) ^{1/2}
1	18	91.8	15.11	50.35	1.000	1.000
2	24	124.2	17.58	58.60	1.164	1.155
3	26	133.7	18.23	60.77	1.207	1.202

Pk ; rf power from klystron

Pac ; circulating power in the system

Eac ; energy gain of the accelerating guide in the system

Ef ; accelerating field on axis in the accelerating field strength

DISCUSSION

The energy gain and the accelerating field gradient

is clearly same to the design specification. On the other hand the energy gain is proportional to route of input power, well.

The input and output coupler cavities of the accelerator guide is off tuned, because of constructing trouble, and it is estimated that the available length of accelerator guide is 30cm.

The measured energies were the broad spectrum as shown in Fig.(4). We think this reason is too wide beam bunch width because the prebuncher and the buncher adjusted insufficiently, and the condition that a beam slit of energy analyzer opened too wide. The vacuum level during this test is 1×10^{-6} Torr because of a leak of the system. Nevertheless the accelerator conditioning time is 40 hours. It's comparatively short. And surprising that the high gradient beam acceleration can be done no baking and such bad vacuum level. So the reason is the clean accelerator guide and the smooth surface of disk hole in the guide that is gathered the electrical field. This fact means a importance of processing technology for the high gradient acceleration.

We had the result comes up to our expectation, however bad test condition, for example the input and output coupler of the accelerator miss adjustment, vacuum leak and accelerator cooling insufficiency. In future we improve thus problems, and hope test using improved accelerator that have higher accelerating ability. And we wish expand this system and technique.

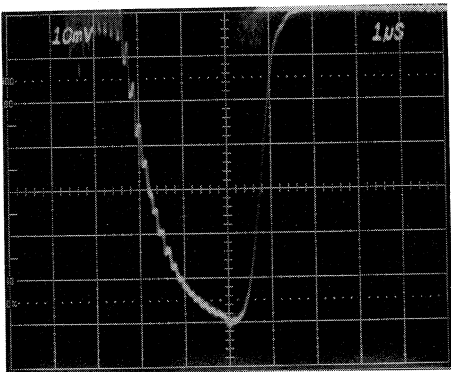

Photo. 1. Pulse shape of the traveling wave in the recirculator system. When rf power was supplied about 26 MW, total circulating rf power was about 134 MW and the rounding number is observed about 17 turns.

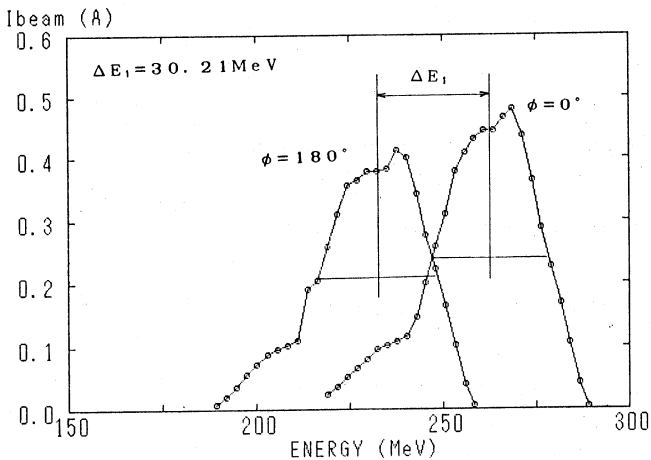

Fig. 4(a). Energy spectrum of accelerating electron beam at the given rf power of 18 MW.

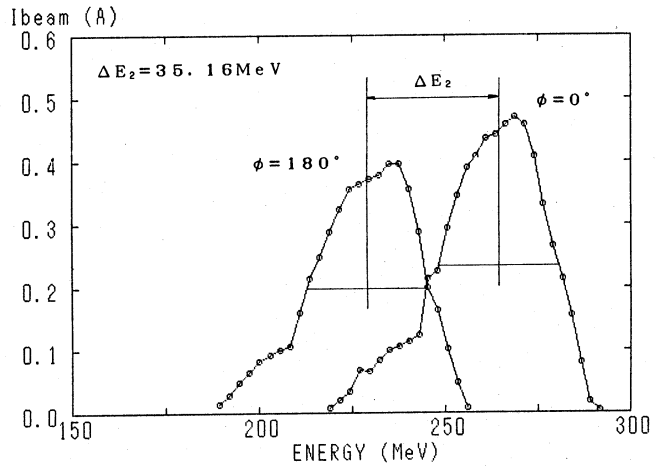

Fig. 4(b). Energy spectrum of accelerating electron beam at the given rf power of 22 MW.

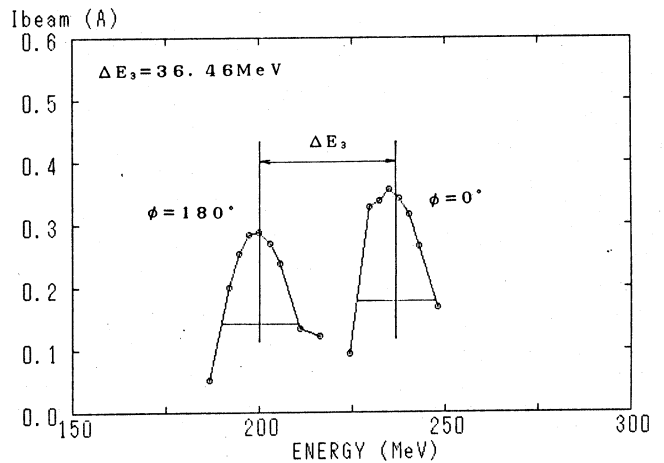

Fig. 4(c). Energy spectrum of accelerating electron beam at the given rf power of 26 MW.

REFERENCE

- 1) Z.D.Farkas, et al., Proc. 9th Int. Conf. on High Energy Accelerator 1974 p576.
- 2) I. Sato, et al., Proc. 12th Linear Accel. Meet. in Japan Aug. 1987 p132.
- 3) H.A. Hoag, et al., Proc. Linear Accel. Conf. June 1986 p437.
- 4) I. Sato, et al., Proc. 5th Sympo. Accel. Sci. and Tec. Sept. 1984 p415.
- 5) J.W. Wang, et al., IEEE Trans. on Nucl. Sci. NS32 Oct. 1985.
- 6) J.W. Wang et al., Proc. Linear Accel. Conf., June 1986 p461.
- 7) H. Matsumoto et al., Published to 1987 IEEE Trans. Particle Accelerator Conf.