

SINGLE BUNCH SYSTEM FOR UVSOR

T.Kasuga, M.Hasumoto, T.Kinoshita and H.Yonehara
 Institute for Molecular Science
 Myodaiji-cho, Okazaki, 444, Japan

ABSTRACT

A new RF knockout system for the single bunch mode operation of the UVSOR storage ring was installed in the injector synchrotron. The knockout signal is modulated by the distorted wave synchronized to the revolution of the beam in the synchrotron for improvement in the purity of the single bunch. The timing system was also modified for various mode operation of the machine.

INTRODUCTION

The UVSOR is a 600MeV electron storage ring dedicated to ultraviolet synchrotron radiation research in molecular science and related fields. The injector is a 600 MeV electron synchrotron with a 15 MeV linac. The radio frequency of the storage ring and the synchrotron is 90MHz; harmonic numbers are 16 and 8 respectively. Therefore, the period of the pulsed light from the ring is about 11ns, when all buckets of the storage ring are filled. The storage ring can be operated in the single bunch mode for some experiments that require the longer pulse period. In this mode, period is elongated to 180ns, which is the revolution period of the beam in the ring. Main parameters of the UVSOR is shown in Table 1.

Two single bunch systems were installed in the UVSOR: the nano-second grid pulser and the RF knockout system. The latter is used routinely since the operation and maintenance of this system is easier than that of the former. In the early days, the knockout signal was modulated by the sine wave synchronized to the revolution of the beam to leave two bunches. (Fig. 1a) There are two weak points in this system; one bunch in two must be dumped before injection into the storage ring and it is difficult to kill the bunches adjacent to the survivor without

influence on it. A new RF knockout system is developed for improvement in these weak points. We also modified the timing system to operate the machine in various modes.

RF KNOCKOUT SYSTEM

The beam circulating in the synchrotron is lost if the frequency of the transverse excitation satisfies the following condition:

$$f_{ko} = \begin{cases} qf_{rev} \\ (1-q)f_{rev} \end{cases}, \quad (1)$$

where f_{ko} is the frequency of the excitation, q the decimal part of the tune and f_{rev} the revolution frequency of the synchrotron. The knockout signal is modulated by a signal synchronized to the revolution frequency to leave one or two bunches. The modulation signal is distorted to avoid the above mentioned weak points. The principle of this system is illustrated in Fig. 1b. The biased fundamental component in the modulation signal knocks out all bunches except aimed one and the second harmonic kills the adjacent bunches perfectly. Figure 2 shows the blockdiagram of the new RF knock system. The burst signal from the synthesizer (Kikusui, Model FGE 3250) is modulated with a modulator, of which diagram is shown in Fig. 3. The spectral lines of the modulated signal

$$f = f_{rev} + f_{ko} + 2f_{rev} + f_{ko} \quad (2)$$

occur. Therefore, the frequency coverage of the system must be at least 5-29MHz. The modulated signal is transmitted from the control room to the synchrotron

Table 1 Parameters of UVSOR

	Designed	Achieved
Linac		
Energy	15 MeV	15 MeV
Synchrotron		
Energy	600 MeV	600 MeV
Current	50 mA	20 mA
Circumference	26.6 m	
Bending Radius	1.8 m	
Radio Frequency	90.1 MHz	
Repetition Rate	1-3 Hz	2.5 Hz
Storage Ring		
Energy	600 MeV (750 MeV)	750 MeV
Critical Wavelength	56.9 Å	
Current	500 mA	500 mA
Lifetime	1 h (500mA)	2.5 h (100mA)
Circumference	53.2 m	
Bending Radius	2.2 m	
Tune (Q_H, Q_V)	(3.25, 2.75)	
Radio Frequency	90.1 MHz	
RF Voltage	75 kV	
Damping Time		
Horizontal	45.4 ms	
Vertical	40.9 ms	
Longitudinal	19.5 ms	
Emittance		
Horizontal	$8\pi \times 10^{-8}$ m rad	$<16\pi \times 10^{-8}$ m rad
Vertical	$8\pi \times 10^{-9}$ m rad*	

*10% coupling is assumed.

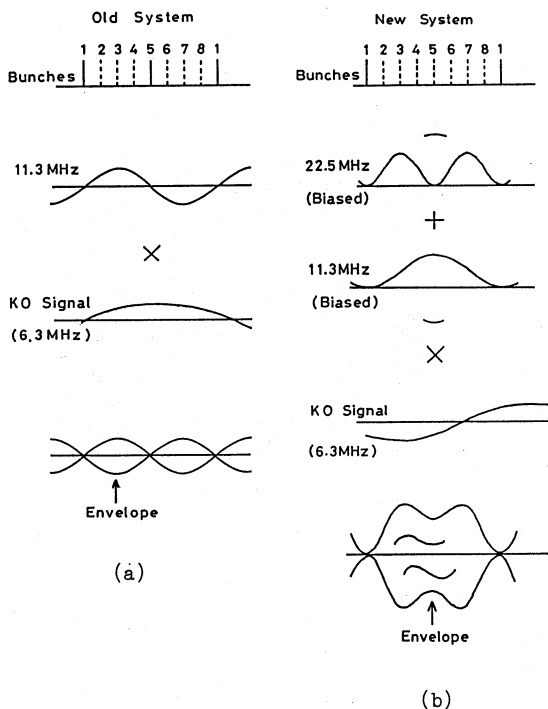

Fig. 1 Wave forms of RF KO system. a:Old system b:New system

and amplified with a wideband power amplifier (ENI, model A300). The electron beam is vertically excited through an excitation electrode which consists of two parallel plates.

Since the spectral bandwidth of the excitation signal is wide, the group delay characteristic of the system is important. The electrode is shunted with a 50Ω dummy load which has a monitor output. The amplitude and phase difference between the fundamental and the 2-nd harmonic of the revolution frequency were adjusted to correct the distortion of the waveform at the electrode due to disorder of the group delay characteristic. An example of the knockout signal at the electrode is shown in Fig. 4. The lower trace in this figure shows the beam signal monitored with a current transformer type fast intensity monitor.

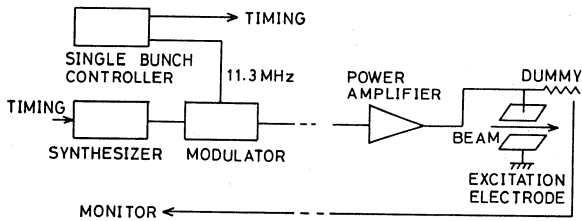
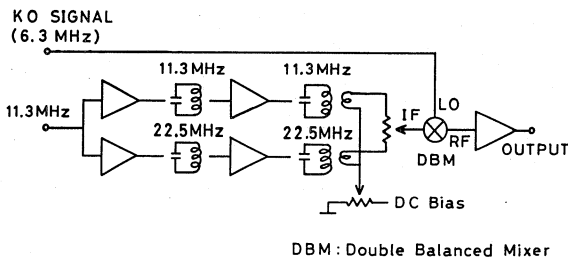

Fig. 2
Blockdiagram of new RF KO system.



DBM: Double Balanced Mixer

Fig. 3
Blockdiagram of modulator for new RF KO system.

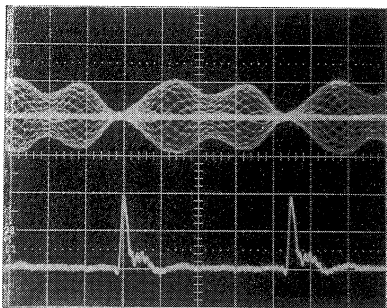

Fig. 4
Knockout signal at electrode (upper trace),
Single bunch in Synchrotron (lower trace).

TIMING SYSTEM

Figure 5 shows the timing system for the beam transfer between the linac, the synchrotron and the storage ring. First, the power supply for the synchrotron magnets is triggered by the master pulse generator, and about 3ms after that the beam from the linac is injected into the synchrotron. The RF knockout signal applied to the beam, about 1ms after injection, i.e., the function generator is triggered and generates the burst wave of which frequency is

qf_{rev} . All bunches except the aimed one are knocked out within several thousands cycles in the burst. The survival bunch is accelerated up to 600MeV and extracted from the synchrotron by means of a first kicker and a deflector. Since the radii of the storage ring and the synchrotron are in the ratio 2:1, there are two storage ring buckets which correspond to a bucket of the synchrotron. The single bunch in the synchrotron has to be transferred to the specified bucket of these two. The synchronization is done by the single bunch control module whose blockdiagram is shown in Fig. 6. Main circuits of the module are octal and binary counters and fast D-type flip-flop circuits. The counters count the radio frequency from the accelerating cavity. The octal counter marks a certain bucket in eight bucket of the synchrotron and the binary counter marks one of two buckets of the storage ring which are synchronized to the specified bucket of the synchrotron. Trigger pulses from the main timing system are synchronized to the marked bucket by means of the D-type flip-flop. When the 90ns delay line is connected after the single bunch control module, the opposite bucket can be selected -- $90ns = (\text{revolution period of the storage ring})/2$ --. The variable delay between the 90ns delay line and the fast kicker pulser compensates the signal delay in cables and the transit time of the beam in the beam transport system. Various mode of operation of the storage ring can be selected with this system as shown in Table 2.

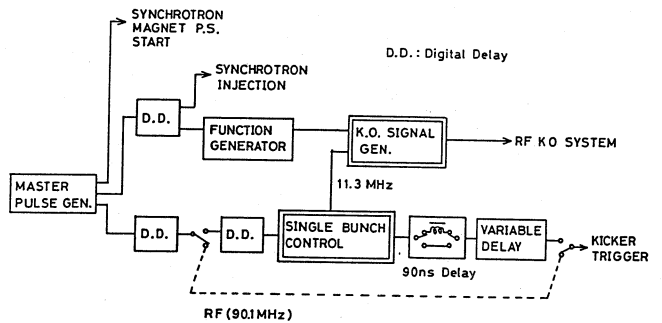

Fig. 5
Blockdiagram of timing System.

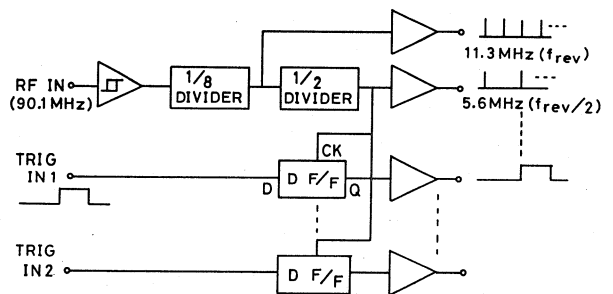

Fig. 6
Blockdiagram of single bunch control module.

Table 2

MODE	RF KO	SINGLE BUNCH CONTROL	90ns DELAY
MULTI-BUNCH	OFF	BY-PASS	BY-PASS
PARTIAL FILLING	OFF	ON	BY-PASS
SINGLE BUNCH	ON	ON	BY-PASS
DOUBLE BUNCH	ON	ON	OFF/ON

CONCLUSIONS

The single bunch can easily be formed in the storage ring with this system. It is difficult to measure single bunch purity in the control room. The current in the adjacent buckets measured with an oscilloscope is less than 1%. This figure can be easily achieved without fine adjustment of the system. When higher purity is required, we must carefully tune the system observing the impurity with a TAC (time to amplitude converter) system for users in the storage ring. An example of the time structure of bunches measured with the TAC system is shown in Fig. 7. The impurities in the adjacent buckets are about 0.1%.

The greater part of the machine studies is performed in the single bunch mode. Since the ion trapping effect, does not occur in the single bunch mode operation, this mode is suitable to observe effects of insertion devices on the tune. Moreover, this mode is also suitable to clarify behaviour of the electron beam, since the single bunch is free from coupled bunch instabilities.

Some experiments using the synchrotron radiation from the single bunch were already done, and this mode of operation will be increased in the future.

ACKNOWLEDGEMENTS

The authors wish to thank Yamanaka of the instrument center of the IMS who kindly offered data on the time structure of bunches.

REFERENCES

1. T.Kasuga, T.Kinosita, M.Hasumoto and H.Yonehara: Proc. 5th Symp. on Accelerator Sci. Tech.(1984) P.295.
2. R.D.Kohaupt : Interner Bericht DESY H1-71/2 (1971).

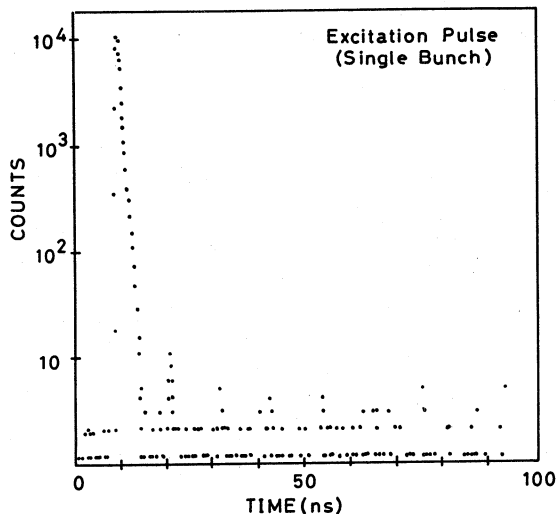

Fig. 7
Time structure of bunches.