

SOME TECHNIQUES TO IMPROVE TIME STRUCTURE OF SLOW EXTRACTED BEAM

Y. Shoji, H. Sato, T. Toyama, K. Marutsuka, T. Sueno, K. Mikawa, S. Ninomiya and M. Yoshii

National Laboratory for High Energy Physics  
1-1 Oho, Tsukuba-shi, Ibaraki-ken, 305, Japan

Abstract

In order to improve the time structure of slow extracted beam spill for the KEK 12GeV PS, the spill control system has been upgraded by adding feed forward signal to feedback signal. Further, the wake field in the RF cavity has been cancelled by the beam bunch signal to reduce the re-bunch effect during extraction period.

Introduction

Beam intensity of KEK 12GeV proton synchrotron is gradually increasing and rare event experiments come to be able to performed [1]. Then the dead time of counting system becomes serious problem. To use full intensity of extracted beam, slow extraction system was upgraded to extend the spill time by a factor of 4 [2,3,4]. In addition to that the improvement of counting system and the efforts to reduce the spill ripple are going on. Here we describe some techniques to improve the spill intensity fluctuation.

Typically half integer resonant extraction from the KEK 12GeV proton synchrotron has been utilized at  $\nu_H=7.5$  [5]. Extraction elements are three quadrupoles, one octupole, electrostatic and magnetic septums and bump magnets [6]. One quadrupole (EQ) control the tune to keep the extracted beam intensity constant. And the other two quadrupoles (RQ) are used to compensate the high frequency component ( more than 100 Hz ) of tune fluctuation [6]. We expect deterioration of spill fluctuation ratio by the extension of extraction time, since the spill fluctuation roughly proportional to  $d\nu_H/dt$  from the ripple of main quadrupoles. We are improving tune fluctuation with following methods. 1) Reduction of ripple of main lattice quadrupoles. 2) Improvement of feed back system. 3) Install of feed forward system. In this paper we describe the third one.

Another origin of the extracted beam spill fluctuation is the re-bunch phenomena or coasting beam instability induced by the impedance of RF cavities. This instability causes not only the high frequency fluctuation ( harmonics of 880 kHz revolution frequency ) but also the lower frequency spikes ( less than 10 kHz ). This instability can be suppressed by feeding the RF voltage which cancels the wake field. This technique was once tried to do for KEK PS [7], but not used in past decade. So the system was reinstalled at this time. The suppression of that instability will be very important for the future project of KEK PS, such as the extraction of deuteron beam [8] or the lower energy proton beam. At these cases the momentum compaction factor or dilution factor may be very small and that instability is likely to occur.

Feed forward system for spill control

The feed back system of spill control is shown in Fig.1. In order to get uniform intensity beam spill, the signal from SEC ( Secondary Emission Chamber ) is compared with the reference signal which is proportional to the circulating beam intensity and feed back to excitation patterns of EQ and RQs. We can not expect drastic improvement of present real time feed back system due to the time lag or phase advance of the system loop. So we added feed forward signals to the present feedback signal as shown also in Fig.1.

There are two approaches to feed the ripple signal from out of feed back loop. 1) The major frequency component of the ripple is the 50 Hz, that is the original AC line frequency. Then 50 Hz signal synchronized to the original line was add to the feed back signal of EQ. The gain and the phase of feed forward signal were adjusted to expel the 50 Hz component from the spill fluctuation. Fig.2 shows the power spectrum of the spill ripple (a) with and (b) without this system. This system does not ask what is the source of ripple, and works very well. 2) The major ripple components

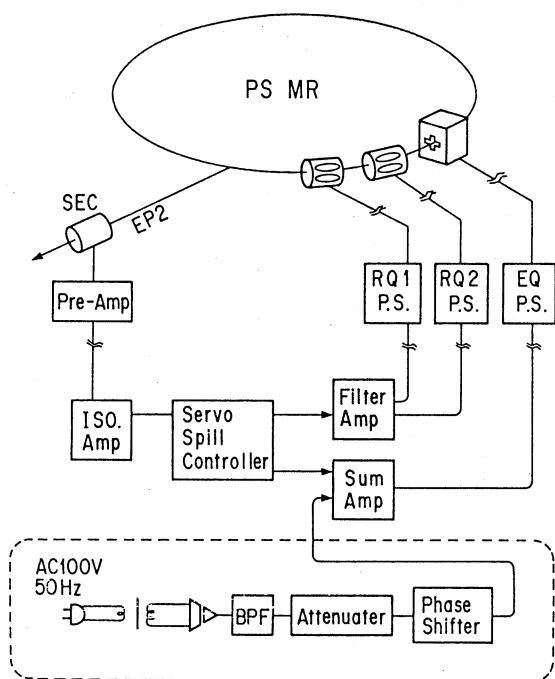

Fig.1. Schematic diagram of spill feed back system and newly installed feed forward system. Added feed forward part is enclosed by broken line. Some kind of feed forward signal source will be set here.

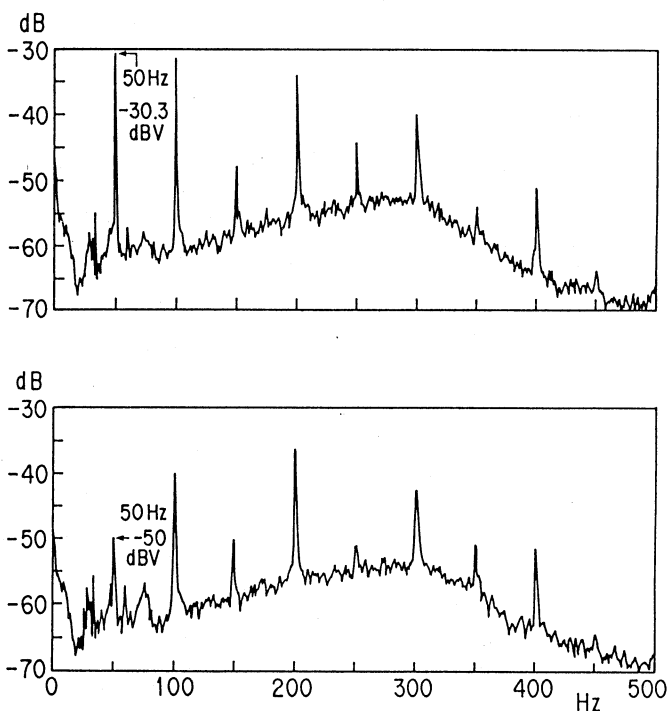
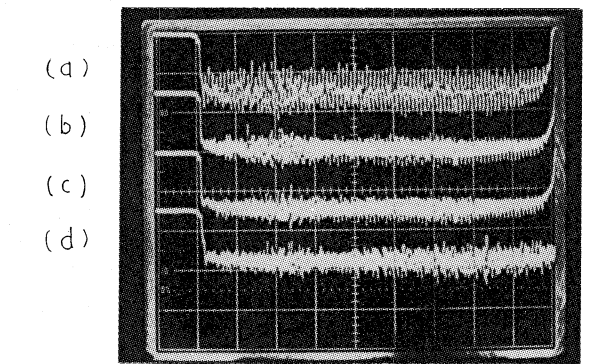
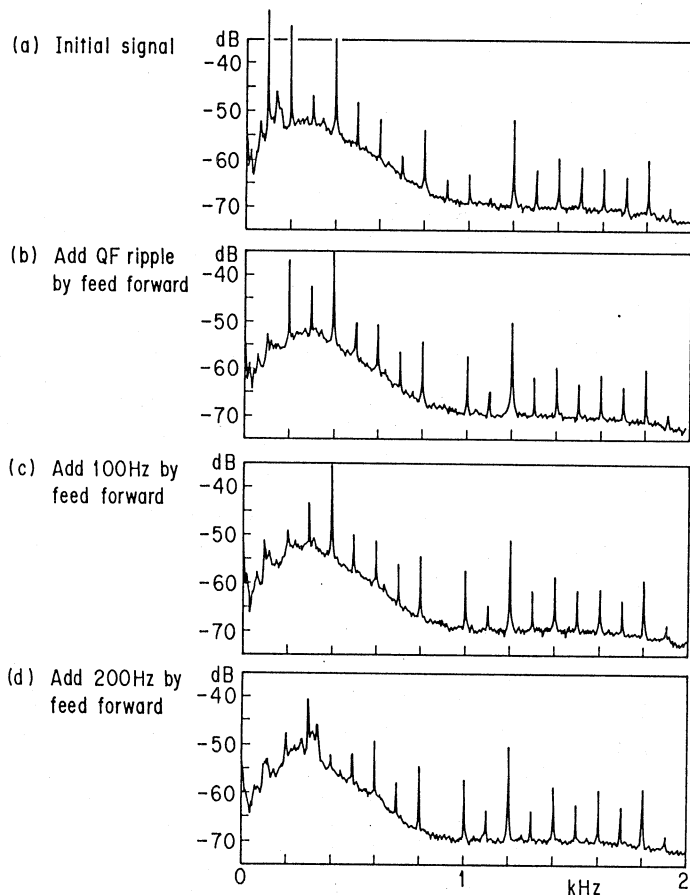
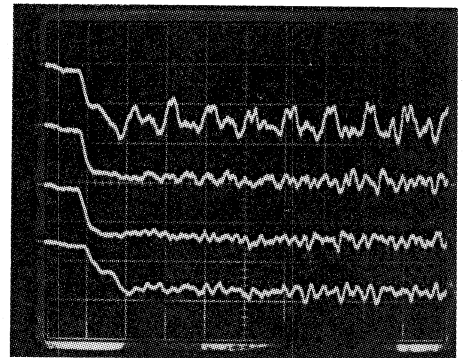

Fig.2. The power spectrum of the spill intensity fluctuation (a) with and (b) without feed forward signal of 50 kHz



200 ms/div



20 ms/div

Fig.3. Improvement of spill intensity fluctuation. (a) is initial fluctuation. (b) feed forward of QF ripple is added. (c) feed forward of 100 Hz signal is added. (d) feed forward of 200 Hz signal is added. The left side figures are power spectrum of them. The upper right is time structures of spill intensity fluctuation. The vertical scale is the same for 4 spectrum. The time scale is 200 ms/div. The lower right is time scale extension of upper right. 20 ms/div.

are caused from the horizontal tune fluctuation by the main focusing quadrupole magnet (QF) ripple. Then the ripple signal measured with search coil in the magnet, is added to the feed back signal of EQ. The feed forward gain was adjusted to minimize the main ripple component of the spill. In Fig.3 shows the power spectrum of the spill ripple (a) with and (b) without this system. This scheme is similar to the system with which the ripple of main quadrupoles was cancelled by air-core quadrupole [9,10].

This system reduced the fluctuation component not only of the 50 Hz peak but also of continuum from about 20Hz to 100 Hz. Then we first applied the latter method and after that applied the former method to expel the residual 100 Hz and 200 Hz ripple component. These have worked well as shown in Fig.3.

When a operator optimize the feed back parameters, sometimes the spike-like high intense beam is extracted at the

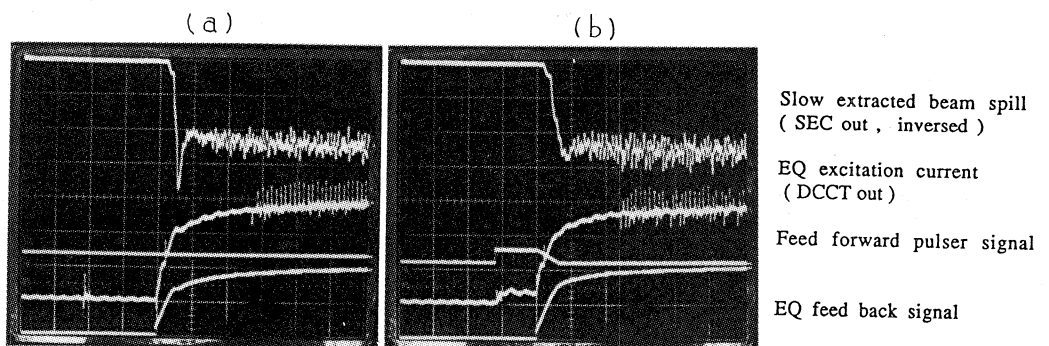

Fig.4. The head of slow extracted beam spill, excitation pattern of EQ and the trapezoid pulse added in order to suppress the overshooting, (a) pulser OFF and (b) pulser ON.

head of beam spill. So in the past, the control parameters was set off from the optimization point to avoid this effect. This spike might be caused from the overshoot response of EQ power supply. Such spike-like beam kills the counter system for a while and physics user much desired to eliminate this effect. We compensated this effect by adding the optional trapezoid pulse signal to the front end of EQ pattern as shown in Fig.4. Now the control parameters are set at the optimized point.

## Reduction of re-bunching phenomena

To suppress the coasting beam instability, the bunch signal of circulating beam was fed to RF voltage pattern. The system is shown in Fig.6. The bunch signal was delayed to the phase at which two main frequency component ( $n=7$  and  $n=8$  harmonic component) would be suppressed, amplified and fed to RF power amplifier. The two of eight RF cavities were used for this feed back. Fig.7 shows bunch signal and time structure of beam spill. The system works very well. The feed back gain was about 5 times higher than expected value. Then there might be unknown coupling impedance around the ring, or the coupling impedance of RF cavities were over cancelled.

## Discussion

In order to get uniform beam spill during extraction, several methods have been tried to compensate the spill fluctuation depend on origin. The feed forward spill control system is also effective complement with feed back loop to reduce rather low frequency component caused from the main quadrupole magnet ripple. The other feed forward method is also effective to clear the large spill spike at the front end of extraction. About rather high frequency component due to re-bunch effect, it is effective that beam bunch signal was fed to RF cavity. Although the beam is extracted for a longer spill such as 2 seconds, the good efficient extracted beam spill is realized. Ideas and hard wares of these system were not the special ones. They were very simple and very easy to control but very effective. And their effect is additive to present feed back system.

We have other plans to reduce the spill ripple. One is feed the high frequency ripple of QF and EQ to fast RQs. That should improve higher frequency component than 100 Hz. The other is application of repetitive control [11] to the spill control system.

This method was adopted in the feed back control system of the main ring power supply [12]. The repetitive control, a number of cycles-delayed feedback, cancels the systematic ripple component which does not change cycle by cycle. The success of feed forward approach 2) shows good feasibility to this method. The third one is feed forward to the extraction bump magnets to stabilize the extracted beam orbit.

## Acknowledgement

The authors wish to acknowledge the continual and helpful co-operation of the PS crew and beam channel group for the performance of these study.

## References

- [1] H. Ejiri, private communication.  
K. Imai, private communication.
- [2] Y. Shoji, et al., presented at this symposium
- [3] H. Sato, et al., Proc. of the 1991 IEEE Particle Conf., San Fransisco
- [4] K. H. Tanaka, et al., KEK Internal 90-17, June, 1990.
- [5] K. Endo and C. Steinbach, KEK-77-13.
- [6] K. Endo, et al., IEEE Trans. on Nucl. Sci., NS-26, 1979
- [7] E. Ezura, KEK Annual Report 1981.
- [8] Y. Mori, et al., presented at this symposium.
- [9] H. T. Edwards, et al., IEEE Trans. on Nucl. Sci., NS-20, 1973.
- [10] S. Ninomiya, KEK Annual Report 1977.
- [11] T. Inoue, et al., T. IEE of Japan100-C,1980.  
N. Nakano, et al., The Society of Instrument and Control Engineers, December 1989.
- [12] T. Sueno, et al., Proc. of the 14th Int. Conf. on High Energy Accelerators, August 22-26, 1989, Tsukuba.  
H. Sato, et al., Proc. of the Power Electronics Specialist's Conf., June 24-28, 1991, Boston

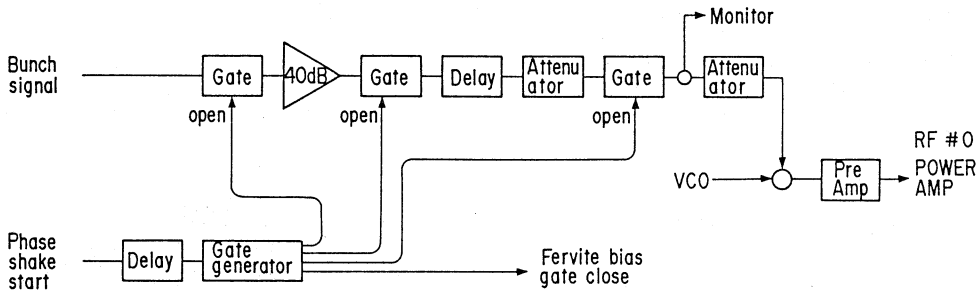

Fig.5. Block diagram of the system to eliminate the RF structure of the debunched beam.

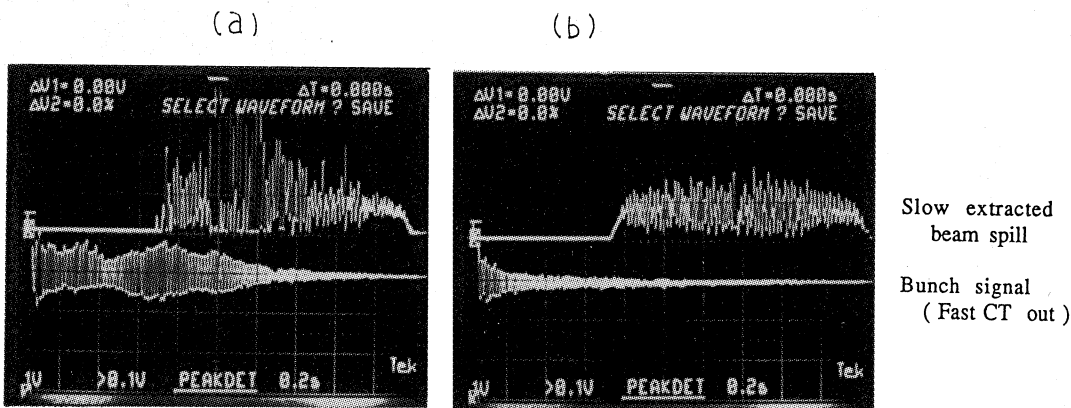

Fig.6. Bunch signal and time structure of beam spill (a) without connection of the system and (b) with connection of the system.