

Development of the Kicker Magnet for SPring-8 Synchrotron

Y.Sasaki, H.Yonehara, H.Suzuki, and T.Aoki
 JAERI-RIKEN SPring-8 Project Team
 JAERI, Tokai-mura, Naka-gun, Ibaraki-ken, 319-11, Japan

Abstract

Fast-pulsed kicker-magnets will be used for the SPring-8 synchrotron in the beam injection and extraction. A prototype kicker-magnet and the power supply were constructed and tested. The kicker magnet has been completed successfully, and the experimental result is reported.

I. INTRODUCTION

The SPring-8 facility consists of 1-GeV linac, synchrotron and 8-GeV storage-ring. The synchrotron is designed to accelerate the beam from 1 GeV to 8 GeV and the circumference is 396.12 m. For the single-bunch mode-operation in the storage ring, the eight equally spaced bunches from the synchrotron are injected one by one into a selected bunch of the storage ring at the rate of 60-Hz. The kicker magnets are required to have a fast rise-time and a fall-time, as the next bunched beam is not affected by the magnetic field of the kicker magnets. The exiting duration of the kicker magnets must be shorter than 320 nsec. The waveform of the magnetic field have 100 nsec rise-time, more than 40 nsec flat-top and 100 nsec fall-time. The kickers are also used for the multi-bunch mode-operation. In this mode-operation, the flat-top is changed into 1.1 μ sec, because the revolution time of the synchrotron is 1.32 μ s.

Two septum magnets and two kicker magnets will be used for the on-axis injection. The beam from the linac is injected into the septum magnets and then, after passing through the magnets, the beam is inflected to the reference orbit by the focusing quadrupoles. The beam is inflected and placed smoothly on the reference orbit by the kicker magnets. Four septum magnets, three kicker magnets and four bump magnets will be used for the beam extraction.

II. MAGNET

The kicker magnet has a transmission-line structure of 10 cells with C-shaped ferrite-cores and electrodes. The coil of the magnet is a single-turn. Thickness of the ferrite core and electrode are 18.5 mm and 4 mm, respectively. The cores and the electrodes are stacked alternately. The cores are placed between the electrodes and they also increase the capacitance. The kicker magnet is placed in the vacuum chamber and two feedthroughs are located on the both ends of the magnet. To minimize the inductance of the feedthrough, the length of the feedthroughs are to be as short as possible. In order to measure the waveform of the current at the inlet and the outlet of the kicker, current transformers are located on the feedthrough. Figure 1 shows the end view of the kicker magnet. Table 1 shows the specification of the prototype kicker magnet.

Table 1. Specification of the kicker magnet

Maximum magnetic field (T)	0.0425
Characteristic impedance (Ω)	27
Gap height (mm)	34
Gap width (mm)	92
Total core length (mm)	230
Number of cells	10
Inductance of a unit cell (nH)	65.1
Capacitance of a unit cell (nF)	44.7

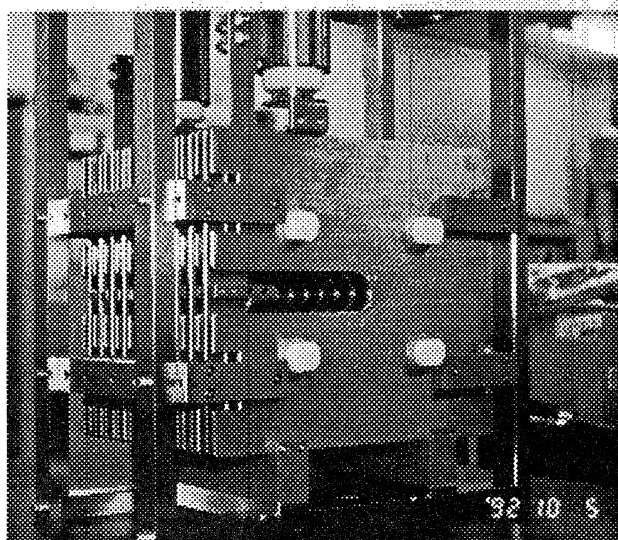

Figure 1. The end view of the kicker magnet

III. POWER SUPPLY

The power supply of the kicker magnet consists of the DC high-voltage power supply, the PFN, the thyatron, the switch of two pulse-modes and the termination. Figure 2 shows the equivalent circuit diagram of the kicker magnet and the power supply. Table 2 shows the parameters of the prototype-kicker power-supply.

Table 2. Specification of the power supply

Charging voltage (kV)	65
Current (A)	1200
Pulse width (ns)	320, 1300
Impedance (Ω)	27
Thyatron type	CX1171(EEV)
Jitter (nsec)	<5

The power supply provides the peak current of 1200 A with the shape of trapezoid, the 40-nsec flat-top for the short pulse and the 1.1- μ sec flat-top for the long pulse. The power supply has two charging cables with different length, 16 m for the short pulse and 120 m for the long pulse.

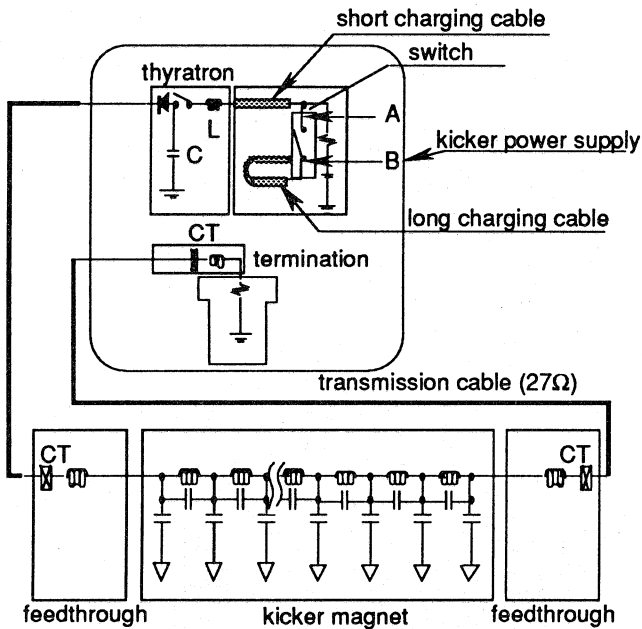

Figure 2. The equivalent circuit diagram of the kicker and the power supply

The kicker magnet and the power supply are connected with the transmission cable. To avoid the reflected current into the flat-top of the short pulse, the cable length must be more than 25 m. In order to minimize the loss in the cable, the length of the cable should be as short as possible. Thus, the length of the cable was decided to be 25 m.

IV. MEASUREMENTS

A. Measurement system

A current transformer (PEARSON-110) and a single-turn long search-coil is used for the measurement of the current and the magnetic field, respectively. The width of the search coil is 5.5 mm, the length is 360 mm. The diameter of the wire is 0.2 mm. The terminal is connected with 1000:1 high-voltage probe and the digital storage oscilloscope. The waveform of the magnetic field was obtained by integrating the induced voltage at the both ends of the search-coil and the integrating function of the oscilloscope was used.

B. Short pulse mode

As shown in figure 3, the flatness of the waveform does not satisfy the specification. The mismatch of impedance and the reflection occur at the feedthrough. To get good flatness, the matching capacitors were connected at the feedthrough. Figure 4 shows the improved magnetic field waveform and the differential waveform at the pole center on the median plane. The optimum values of the capacitance were 248 pF at

the inlet and 260 pF at the outlet. The rise time of the waveform is about 75 nsec, and the accuracy at the flat-top is less than 2%. These results satisfy the specification.

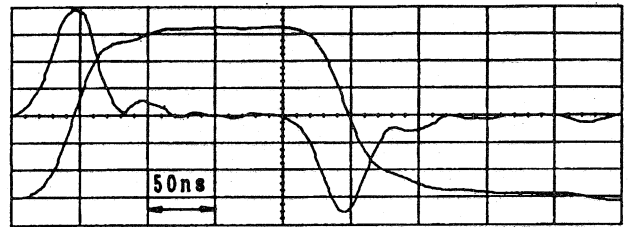

Figure 3. The magnetic field waveform and the differential of the waveform without the capacitors

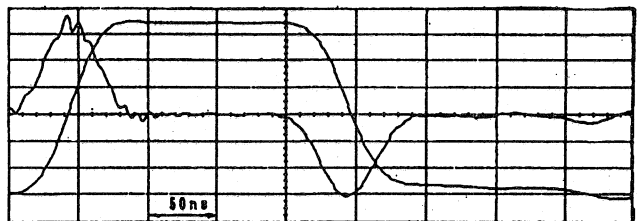

Figure 4. The magnetic field waveform and the differential of the waveform with the capacitors

C. Long pulse mode

Figure 5 shows the current waveform at the entrance of the kicker in the long pulse mode. A dip is observed 150 nsec after the beginning of the flat-top. For the long pulse mode, two charging cables are connected in series by the switch. As the switch has the inductance of 0.3 μ H, the dip occurs as the result of the reflected current. In order to minimize the dip, two matching capacitors were connected with the switch (at the points of A and B in Figure 2). The dip was almost removed by using the capacitor of 167 pF. Figure 6 shows the current waveform with the matching capacitors. Figure 7 shows the integrated magnetic field waveform with the matching capacitors.

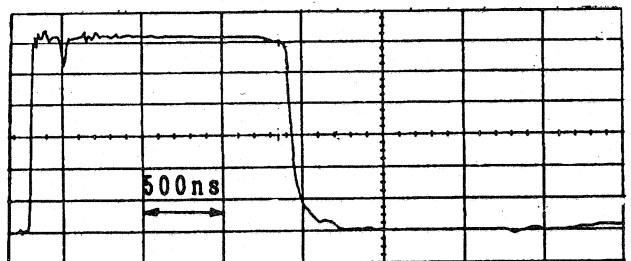

Figure 5. The current waveform of the long-pulse-mode

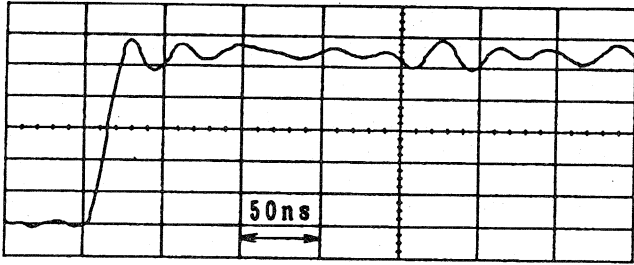

Figure 6. The current waveform of the long-pulse-mode with the matching capacitors

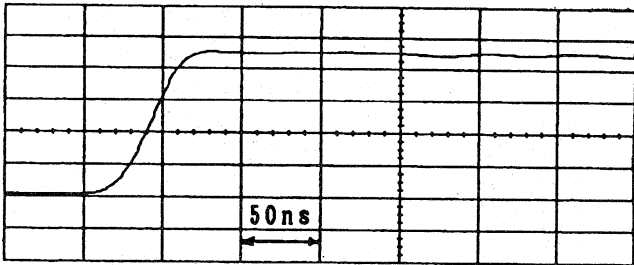

Figure 7. The magnetic field waveform of the long pulse mode with the matching capacitors

D. Transverse field distribution measurement

Figure 8 shows the transverse distribution of the integrated field on the median plane. The specification require that the uniformity of the field should be less than 2 % in the range of 30 mm and the requirement is achieved.

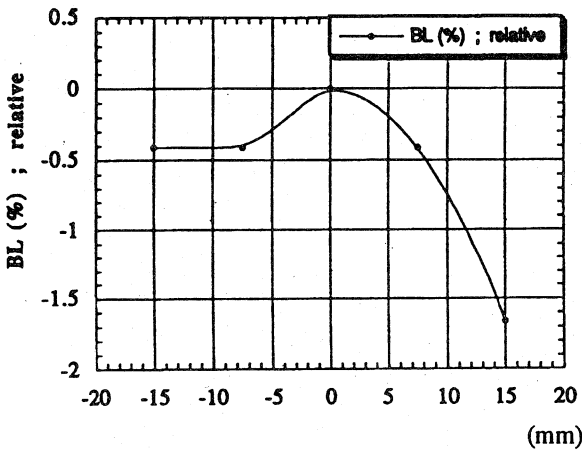

Figure 8. The transverse distribution of the integrated field

V. CONCLUSION

The experiments of the kicker magnet and the power supply are completed successfully. The results of the experiments can be applied for the design of the injection and extraction kickers. A few parts of the kicker will be improved.

VI. ACKNOWLEDGMENTS

Thanks to Dr. H. Tazawa, Dr T. Kawakubo for their useful comments and we are grateful to Mr. I. Toyama, Nichicon Co.,Ltd. for the technological support and discussion. Thanks to Mr. H. Hashimoto, Hitachi, Ltd. for giving us the suggestion for design.

IV. REFERENCES

- [1] M.J.Barnes, G.D.Wait " KICKERS FOR THE KAON TRIUMF, 4004 Wesbrook Mall, Vancouver, B.C., Canada V6T 2A3
- [2] F. Bulos et al., "Some Fast Beam Kicker Magnet Systems at SLAC", PAC Record 87CH2837-9, Washington, D. C., March 1987, pp 1884-6
- [3] L.Bartelson et al., " Kicker for Stanford Linear Accelerator Center Damping Ring", id., pp. 1582-4