

Development of Beam Position Monitor of the Transport Line from LINAC to AR in TRISTAN

M.Teijima, M.Satoh and K.Mori
National Laboratory for High Energy Physics (KEK),
Oho 1-1, Tsukuba, Ibaraki, 305, Japan

Abstract

We constructed and installed 9 Beam Position Monitors(BPM) having four strip-lines along the beam transport line from the linac to the accumulating ring(AR) last summer. Every signal was gathered in the local control room, the beam signal is measured by using the digitizing oscilloscope and sent to the micro-computer(μ -com) through the GPIB. The picture of beam positions on the μ -com terminal is converted to the video signal and transmitted to a TV monitor at the central control room.

1. Introduction

The beam transport line is shown in Fig.1. The transport line transfers electron or positron beam of 2.5GeV from LINAC to AR. There are already 29 units of the fluorescent screen monitor to diagnose the beam orbit and profile. The adjustment of the orbit is handled very carefully by specialists while watching a TV monitor displaying the image of the screen monitor. They often have to adjust the orbit in order to maintain a good transfer efficiency from linac to AR. Then they must put in and out the screen monitor in the vacuum duct one by one, because the screen monitor intercepts the beam passage. Therefore, the operation takes a long time to adjust the wrong orbit. For this reason, we decided to design and construct the beam position monitor system for the transport line.

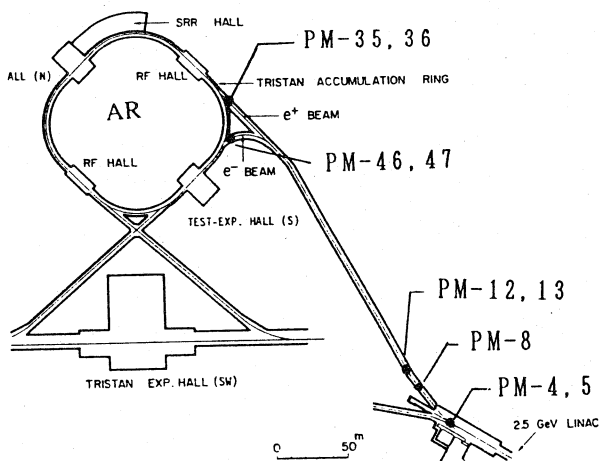

Fig.1 Beam position monitor locations.

2. Monitor chamber

The beam in the transport line has a smaller current as compared with AR and Main Ring. For example, the peak current of the electron beam is 150mA, and that of the positron beam is 20mA. The longitudinal length of the beam is about 30cm, that is, just 2nano seconds in timebase. The beam passes along the transport line repeatedly at intervals of 40m seconds. Before starting of the construction every monitor chamber, we had investigated with a model monitor, that, how? the output level of the beam signal and some noise from injection devices, such as kicker magnets and septum magnets? The result was that the strip-line electrode output is sufficient signal even for detecting the positron beam.

A strip-line electrode couples electromagnetically with the beam current. Now, if the beam current is $I_b(t)$, the output voltage ($V(t)$) of stripline electrodes is given by

$$V(t) = \frac{\phi}{4\pi} Z \left\{ I_b(t) - I_b\left(t - \frac{2L}{c}\right) \right\}$$

where L is electrode length, ϕ is the azimuthal width and Z is the transmission line impedance.

Finally, We adopted a strip-line type monitor to pickup as shown in Fig.2, which has almost the same dimension as those installed between AR and MR of TRISTAN[1].

- The transfer impedance(Z) is 50 Ω .
- The length (L) is 240mm.
- The azimuthal width (ϕ) is 45 degrees.
- The downstream port is short.

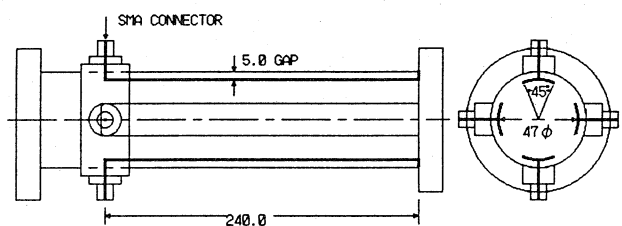

Fig.2 a strip-line type monitor chamber.

We fabricated nine monitor chambers upon which were mounted four electrodes. Matching of the transfer impedance of electrode is measured by using a time domain reflectrometer, as shown in Fig.3. The impedance mismatching(50 Ω) between the output and the transmission line is sufficiently small.

PM4

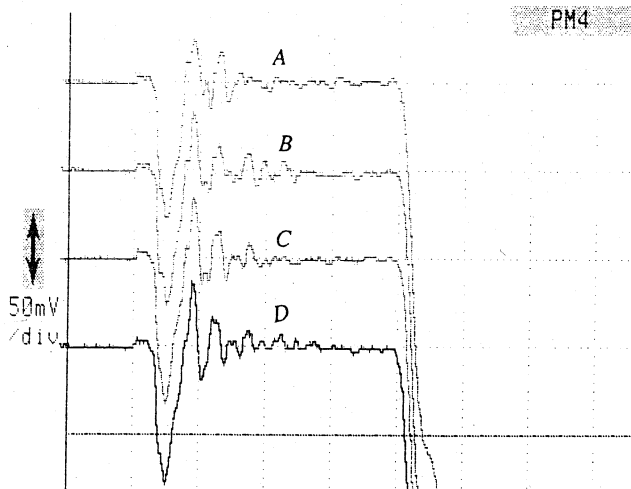

Fig.3 TDR response of a strip-line type electrode
The waveform is output of each electrode
50mV/div. , 500ps/div.

3. BPM location

Nine BPM chambers were set at the important location for adjustment the beam orbit[2]. The location and the name of Q-magnet is shown as Table.1 and Fig.1. BPM-4 and BPM-5 were installed between Q-4 and Q-5, having a role to monitor the beam orbit from the Linac. BPM-8 near Q-8 is important for monitoring the energy deviation of the beam. According to our experience, BPM12 and BPM13 are useful for keeping a good transport efficiency. Remaining BPMs are to stabilize the injection orbit into AR, that is, BPM35 and BPM36 are for the positron beam, and BPM46 and BPM47 are for the electron beam. The cable length between BPM and the local control room is very long, from 140m to 210m.

BPM Name	Location	Cable Length
PM-4	QMAG-4	209.5m
PM-5	QMAG-5	206.5
PM-8	QMAG-8	181.0
PM-12	QMAG-12	145.0
PM-13	QMAG-13	134.0
PM-35	QMAG-35	170.5
PM-36	QMAG-36	170.5
PM-46	QMAG-46	148.0
PM-47	QMAG-47	146.5

Table 1. BPM location and Cable length

4. Signal processing.

The waveform of induced output signal from the strip-line electrode is observed with a digitizing oscilloscope having performance of 2 Giga samples/second digitizing rate. The typical peak to peak voltage V_{p-p} are 400mV for electrons and 50mV for positrons. Fig.4 shows the waveform of the electron and positron beams. We adopted a simple

signal processing method which is composed of four nine 9-ports combiners, a digitizing oscilloscope and a micro-computer to handle the oscilloscope as shown in Fig.5.

Every signal of BPM is sent to the local control room through its own coaxial cable. The signals are classified into four groups (ex. group of A,B,C and D by every four electrodes).

In each group, the nine signals, each having the different delay time, are combined into one signal line. Four grouped signals are connected to the 4-channel oscilloscope, and hence, every signal from BPM (9×4 signals) are sampled in the same time. The 8-bits sampled data are stored in the memory, and its record length is 2000 samples per channel. Therefore, the sampled data contains all beam signals from BPM's as shown in Fig.6.

The μ -com controls the oscilloscope remotely via the GPIB interface, for example, changing the data acquisition mode from one to the other beam, as electron or positron mode, receiving the data from the memory. After all data are read into the buffer area of μ -com, the μ -com calculates for each beam position(X,Y) and the sum of four data.

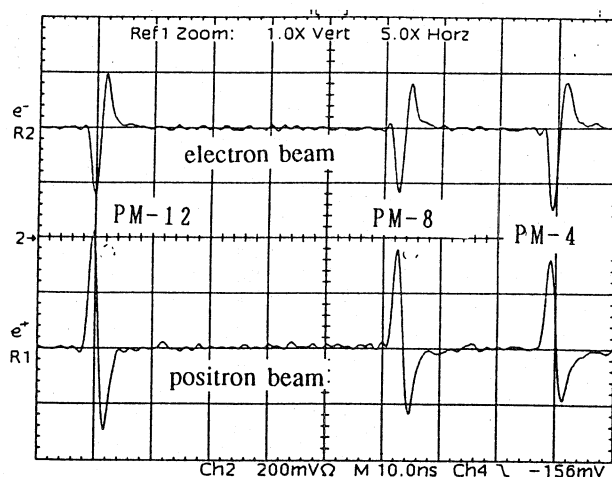

Fig. 4 Waveform for electron or positron beam.
Upper is electron beam, 200mV/div., 10ns/div.
Lower is positron beam, 20mV/div., 10ns/div.

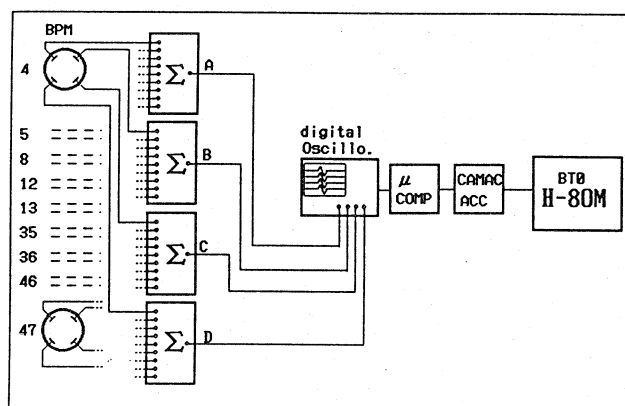

Fig.5 Block diagram of the measurement system

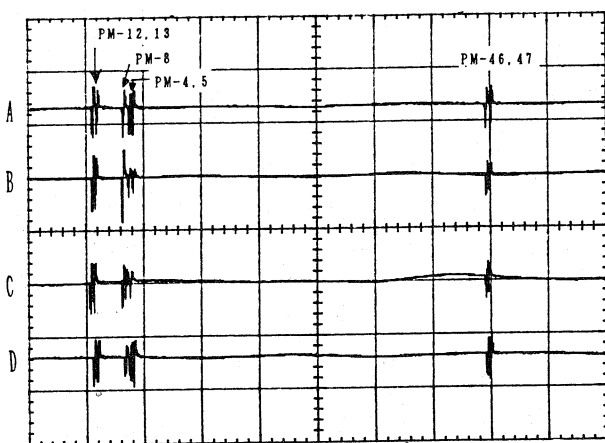

Fig. 6 Timing position of waveforms from the combiner,
Hor. scale is 100ns/div., ver. scale is 150mV/div.

Now, in order to obtain the beam position, the following two calculating steps are necessary. The first is the normalization procedure to obtain electrical positions(H,V), that are given by

$$H = \frac{A - B - C + D}{SUM}, \quad V = \frac{A + B - C - D}{SUM}$$

where $SUM = A + B + C + D$.
A,B,C,D are the induced voltages of four electrodes.
Second, we convert the electrical position to the geometrical position(X,Y) following a first order approximation as

$$X = K_x \cdot H, \quad Y = K_y \cdot V$$

where K_x and K_y are coefficients of sensitivity which are determined by the geometry the monitor chamber. We obtained K_x and K_y with analytical method.

5. Performance

The measurements are supervised by the μ -com in response to some switch such as gain of measurement and trigger position. The μ -com judges the beam mode from the time lag between the electron and positron beams, and then sets the gain as well as the trigger position of the oscilloscope.

The performances of the BPM system is as follows,

- The resolution of position is about 100 μ m rms.
- The accuracy is 0.5mm, which means the estimated the difference between the electrical and geometrical centers of the monitor.
- The maximum rate of the continuous measurements is 1Hz.

- The history of the variation of beam positions is displayed on the μ -com terminal of without a break.
- The above picture is transmitted simultaneously to a TV in the central room.

A sample of the variations of the beam positions and intensities is shown in Fig. 7.

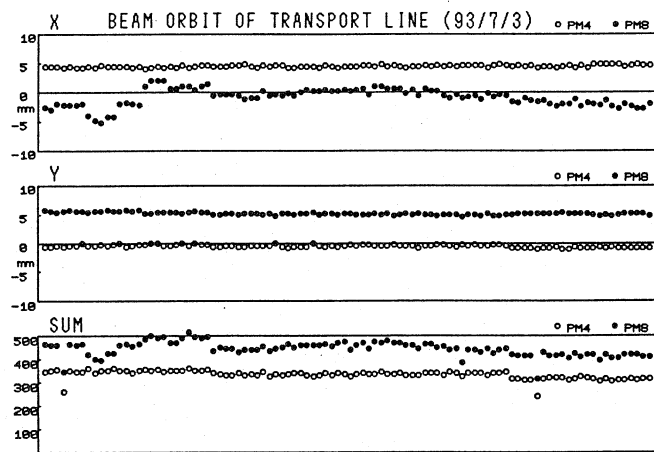

Fig.7 Position and sum variation of the electron beam
Horizontal scale is measurement points for 17 hours.

6. Summary

We constructed a very simple system for measuring the beam position along the AR injection line. The system is composed of 9 stripline monitors, 4 combiner circuits, a digitizing oscilloscope and a μ -computer. Owing to rapid development of technology in this field, we have realized this application easily.

The present accuracy of the beam position measurement satisfies the requirement in the beam transport line, less than 0.1mm. In the future we are going to improve it interpolation of the acquired data points.

We are able to observe the beam position without intercepting the beam at important locations for the beam line tuning. This system will helpful for maintaining a good transfer efficiency.

Acknowledgments

We wish to thank KEK Vacuum Group for helping the construction of BPM chambers. We also wish to thank Dr.K.Satoh, Dr.T.Ieiri, Dr.H.Fukuma for useful some comments.

References

- [1] T.Ieiri and M.Arinaga, A Single-Passage Beam-Position Monitor System for the TRISTAN AR-to-MR Transport Lines,KEK Report 93-02(1993).
- [2] K.Satoh, private communication.